



**Lemi**<sup>®</sup>  
ITALIAN WELLNESS EQUIPMENT



**MEDICAL  
&  
PODIATRY  
Pricelist 2021**

May - 2021

**Brusaferrì & C. srl**  
Via Mara Maretti Soldi, 13  
26011 Casalbuttano (CR) Italy  
phone +039 0374 363069  
info@lemigroup.it

[www.lemigroup.com](http://www.lemigroup.com)



# LEMI PRICE LIST 2021

NEW SETUP, HOW TO MAKE AN ORDER AND HOW TO USE THE NEW PRICE LIST.

Fill in the order following the information boxes in each product page.  
Each product page includes:

1

Information box with **BASIC DESCRIPTION** of the product and **BASIC PRICE**.

2

Information box with basic options to be necessarily selected.

Options marked as **INCLUDED** are already included in basic price.

**N.B:** please, note that if you do not select any option, the product will be configured with options marked as **INCLUDED**.

3

Information box with **EXTRA OPTIONS** to be selected for product customisation.



**Dimensions**  
190x62x62/92h cm  
74,8x24,4x24,4/36,2h"

**Packing**  
170x74x86h cm  
67x29x33,8h"

**Weight**  
87 Kg

**cod. 948**  
**LEMI4**  
Electrically adjustable chair

**Included:**

- 4 motors (height, back rest, leg rest, trendelenburg)
- Flat mattress
- Handset control with automatic function

**Base Price: € 3.020,00**

**FRAME COLORS**

White Grey Black

**CONTROLS**

**INCLUDED** **cod. KEE00468** Handset control € --,--

**cod. LEM-067** Foot pedal control € 156,00

**or** **cod. LEM-180** Wireless foot pedal control (NO foot pedal with cable NO remote control) € 219,00

**MATTRESS**

**INCLUDED** **cod. 990** Standard mattress € --,--

**cod. 109** Anatomic mattress € 208,00

**cod. 100** Extra comfort mattress with Memory Foam 15cm € 271,00

**cod. XL 70** Mattress XL 70cm € 271,00

SINGLE STITCH (tone on tone) STANDARD

DOUBLE STITCH (contrasting white or brown) OPTIONAL

NO STITCHES OPTIONAL

**SEAT**

**INCLUDED** **cod. 959** Fixed seat € --,--

**cod. ROT** Seat with 180° rotation € 156,00

**ELECTRIC SYSTEM**













**INCLUDED** **cod. KEE00462** EU Cable 230V € --,--

**cod. KEE00463** UK Cable 230V € --,--

**cod. KEE00465** USA Cable 110V € --,--

**cod. KEE00464** Australian Cable 240V € --,--

**ACCESSORIES UPON REQUEST**

 <b>cod. 208M</b> Flat armrest couple € 260,00	 <b>cod. 311</b> I.V. Rod (fixed with rotating clamp and guides on the back) € 94,00
 <b>cod. 114 P</b> Mattress protection with polyurethane € 90,00	 <b>cod. 334 / cod. 334 XL</b> Seat guides couple / Seat guides couple XL € 198,00
 <b>cod. 108 / 108 XL</b> Roll holder (66 / 75 cm) € 41,00	 <b>cod. 335 / cod. 335 XL</b> Back guides couple / Back guides couple XL € 198,00
 <b>cod. PROT.GAMBE</b> Plastic leg protection € 48,00	 <b>cod. 345</b> Fixed clamp € 91,00
 <b>cod. LEM-139</b> Wheels with brake (ø 50 mm) € 18,00 ea.	 <b>cod. 346</b> Rotating clamp € 91,00
 <b>cod. 315</b> Curtain holder (fixed with rotating clamp and guides on the seat) € 57,00	 <b>cod. LEM-151</b> Heel support couple (fixed with fix clamp and guides on the seat) € 448,00

MANDATORY

UPON REQUEST

# LEMI PRICE LIST 2021

## HOW TO FILL IN THE ORDER?

- 1 - Put the product name.\*
- 2 - Put the base finishing.\*
- 3 - Put the mattress color.\*
- 4 - Put the basic options to be necessarily selected.\*
- 5 - Put the extra options if required.

**N.B:** Also put quantities for all the products and options.

## OPTION 01

### EXAMPLE OF DESCRIPTIVE ORDER:

- 1 x 948 LEMI 4 - Put the product name and reference code.\*
- 1 x White - Put the base finishing.\*
- 1 x 06 Nefos - Put the mattress color.\*

#### Put basic options to be necessarily selected.\*

- 1 x cod. LEM-180 Wireless Foot Pedal
- 1 x cod. KEE0046 EU Cable 230V
- 1 x cod. 990 Standard Mattress
- 1 x cod. ROT Seat with rotation

#### Put extra options if required.

- 1 x cod. PROT GAMBE - Leg protection
- 1 x cod. LEM-139 - Wheels
- 1 x cod. 334 - Seat Guides

## FABRICS

The images are for illustrative purposes only and may not reflect the actual finish of the product, particularly when viewed through a screen.

Therefore, the **SELECTION** of the mattress **FABRICS** must take place **AFTER CONSULTING** the **PHYSICAL SAMPLES** of the NEFOS **COLOR CHART**.

# OPTION 02

## EXAMPLE OF CHOICE FROM PRICE LIST OPTIONS:

Put the product name.\*  
Put the basic options to be necessarily selected.\*



**Dimensions**  
190x62x62/92h cm  
74,8x24,4x24,4/36,2h"

**Packing**  
170x74x86h cm  
67x29x33,8h"

**Weight**  
87 Kg

### cod. 948 **LEMI 4**

Electrically adjustable chair

**Included:**

- 4 motors (height, back rest, leg rest, trendelenburg)
- Flat mattress
- Handset control with automatic function

Base Price: € 3.020,00

#### FRAME COLORS

~~White~~   Grey   Black

#### CONTROLS



**INCLUDED**

cod. KEE00468   € --,--  
Handset control



cod. LEM-067   € 156,00  
Foot pedal control

OR



cod. LEM-180   € 219,00  
Wireless foot pedal control (NO foot pedal with cable NO remote control)

#### MATTRESS

~~Standard mattress~~   **INCLUDED**  
cod. 990   € --,--  
Standard mattress



cod. 109   € 208,00  
Anatomic mattress



cod. 100   € 271,00  
Extra comfort mattress with Memory Foam 15cm

**SINGLE STITCH (tone on tone)**   STANDARD  
DOUBLE STITCH (contrasting white or brown)   OPTIONAL  
NO STITCHES   OPTIONAL

**XL**  
cod. XL 70   € 271,00  
Mattress XL 70cm

#### SEAT

~~Fixed seat~~   **INCLUDED**  
cod. 959   € --,--  
Fixed seat

~~Seat with 180° rotation~~   € 156,00  
cod. ROT  
Seat with 180° rotation

#### ELECTRIC SYSTEM

~~EU Cable 230V~~   **INCLUDED**  
cod. KEE00462   € --,--  
EU Cable 230V

USA Cable 110V   € --,--  
cod. KEE00465  
USA Cable 110V

UK Cable 230V   € --,--  
cod. KEE00463  
UK Cable 230V

Australian Cable 240V   € --,--  
cod. KEE00464  
Australian Cable 240V

MANDATORY

## OPTION 02

### EXAMPLE OF CHOICE FROM PRICE LIST OPTIONS:

Put the extra options if required.

#### ACCESSORIES UPON REQUEST

	<b>cod. 208M</b> Flat armrest couple	€ 260,00		<b>cod. 311</b> I.V. Rod (fixed with rotating clamp and guides on the back)	€ 94,00
	<b>cod. 114 P</b> Mattress protection with polyurethane	€ 90,00	<del></del>	<b>cod. 334 / cod. 334 XL</b> Seat guides couple / Seat guides couple XL	€ 198,00
	<b>cod. 108 / 108 XL</b> Roll holder (66 / 75 cm)	€ 41,00		<b>cod. 335 / cod. 335 XL</b> Back guides couple / Back guides couple XL	€ 198,00
<del></del>	<b>cod. PROT.GAMBE</b> Plastic leg protection	€ 48,00		<b>cod. 345</b> Fixed clamp	€ 91,00
<del></del>	<b>cod. LEM-139</b> Wheels with brake (ø 50 mm)	€ 18,00 ea.		<b>cod. 346</b> Rotating clamp	€ 91,00
	<b>cod. 315</b> Curtain holder (fixed with rotating clamp and guides on the seat)	€ 57,00		<b>cod. LEM-151</b> Heel support couple (fixed with flx clamp and guides on the seat)	€ 448,00

UPON REQUEST

# INDEX

pag. 7	Lemi 4	
pag. 9	Lemi 4 Bi-Zak	
pag. 11	Lemi Syncro Bi-Zak	
pag. 13	Lemi 3	- AESTHETIC SURGERY
pag. 15	Lemi 3 Bi-Zak	- DERMATOLOGY
pag. 17	Lemi 2	
pag. 18	Lemi 2 Bi-Zak	
pag. 19	Tesera 4 M	
pag. 21	Lemi Med	
pag. 22	- Lemi Med Haemodialysis / Blood sample	- HAEMODIALYSIS
pag. 23	- Lemi Med Ginecology	- BLOOD SAMPLING
pag. 24	He-Move	
pag. 25	Ke-Treat	- CHEMOTHERAPY / ONCOLOGY
pag. 26	Dreamed 4 M	
pag. 27	Dreamed 4 M Move	- ENT
pag. 28	Dreamed Zak 4 M	- OPHTHALMOLOGY
pag. 29	Dreamed Zak 4 M Move	- DENTISTRY
pag. 30	Dentamed	
pag. 31	Dentamed Move	
pag. 32	Hair Tech	- TRICHOLOGY
pag. 33	Gyno Plus	
pag. 34	Gyno	- GYNAECOLOGY
pag. 35	Hydrogyno	
pag. 36	Lemi Physiobed	
pag. 37	Sosul	- DIAGNOSTICS
pag. 38	Well	- PHYSIOTHERAPY
pag. 39	Somed	
pag. 40	PODO 5	
pag. 41	PODO HIGH	
pag. 42	PODO BRUSO	
pag. 43	PODO DREAM	
pag. 44	PODO MIX 3M	- PODOLOGY
pag. 45	PODO MIX 2M	
pag. 46	PODO MIX 1M	
pag. 47	PODO SLINDER	
pag. 48	Medical lamps	
pag. 51	030 / 030 S	
pag. 52	030 PEDI / 030 S PEDI	
pag. 53	050 / 050 S	
pag. 54	050 PEDI / 050 S PEDI	
pag. 55	021 / 021 S	
pag. 56	035 / 035 S	- STOOLS
pag. 57	052 / 052/S	
pag. 58	015 / 015 PEDI	
pag. 59	019 / 019 PEDI	
pag. 60	070 A	
pag. 61	010 / 010 S	
pag. 62	040 / 040 S	

cod. 948

# LEMI 4

Electrically adjustable chair

### Included:

- 4 motors (height, back rest, leg rest, trendelenburg)
- Flat mattress
- Handset control with automatic function

Base Price: € 3.020,00



**Size**  
190x62x62/92h cm  
74,8x24,4x24,4/36,2h"

**Packing (ea. carton)**  
170x74x86h cm  
66,9x29,1x33,8h"

**Weight (packed)**  
80 Kg

### FRAME COLORS

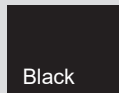
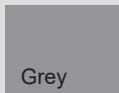
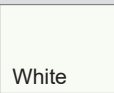

### CONTROLS



INCLUDED

cod. KEE00468  
Handset control € --,--



cod. LEM-067  
Foot pedal control € 156,00

OR



cod. LEM-180  
Wireless foot pedal control (NO foot pedal with cable NO remote control) € 219,00

### MATTRESS



INCLUDED

cod. 990  
Standard mattress € --,--



cod. 109  
Anatomic mattress € 208,00



cod. 100  
Extra comfort mattress with Memory Foam 15cm € 271,00

SINGLE STITCH (tone on tone) STANDARD  
DOUBLE STITCH (contrasting white or brown) OPTIONAL  
NO STITCHES OPTIONAL



cod. XL 70  
Mattress XL 70cm € 271,00

### SEAT



INCLUDED

cod. 959  
Fixed seat € --,--



cod. ROT  
Seat with 180° rotation € 156,00

### ELECTRIC SYSTEM



INCLUDED

cod. KEE00462  
EU Cable 230V € --,--



cod. KEE00463  
UK Cable 230V € --,--



cod. KEE00465  
USA Cable 110V € --,--



cod. KEE00464  
Australian Cable 240V € --,--

### ACCESSORIES UPON REQUEST



cod. 208M  
Flat armrest couple € 260,00



cod. 114 P  
Mattress protection with polyurethane € 90,00



cod. 108 / 108 XL  
Roll holder (66 / 75 cm) € 41,00



cod. PROT.GAMBE  
Plastic leg protection € 48,00



cod. LEM-139  
Wheels with brake (ø 50 mm) € 18,00 ea.



cod. 315  
Curtain holder (fixed with rotating clamp and guides on the seat) € 57,00



cod. 311  
I.V. Rod (fixed with rotating clamp and guides on the back) € 94,00



cod. 334 / cod. 334 XL  
Seat guides couple / Seat guides couple XL € 198,00



cod. 335 / cod. 335 XL  
Back guides couple / Back guides couple XL € 198,00



cod. 345  
Fixed clamp € 91,00



cod. 346  
Rotating clamp € 91,00



cod. LEM-151  
Heel support couple (fixed with flx clamp and guides on the seat) € 448,00

MANDATORY

UPON REQUEST

## ACCESSORIES UPON REQUEST

	<b>cod. 313</b> Medical armrest couple (to be fixed with rotating clamp and guides on the back)	<b>€ 281,00</b>
	<b>cod. 318</b> Thigh supports couple (fixed with fix clamp and guides on the seat)	<b>€ 448,00</b>
	<b>cod. 1162</b> Blood sample taking armrest couple (fixed with fix clamp and guides on the seat)	<b>€ 458,00</b>
	<b>cod. 354 NEW</b> Inox tray with support (fixed with fix clamp and guides on the seat)	<b>€ 198,00</b>
	<b>cod. NO CUCITURE</b> Option for mattress without stitching	<b>€ --,--</b>
	<b>cod. LOGO</b> Customized mattress with logo	<b>€ 136,00</b>





**Size**  
190x62x62/92h cm  
74,8x24,4x24,4/36,2h"

**Packing (ea. carton)**  
170x74x86h cm  
66,9x29,1x33,8h"

**Weight (packed)**  
78 Kg

**cod. 957**  
**LEMI 4 BI-ZAK**

Electrically adjustable chair

**Included:**

- 4 motors (height, back rest, leg rest, trendelenburg)
- Bi-Zak mattress
- Handset control with automatic function

**Base Price: € 3.110,00**

**FRAME COLORS**



**CONTROLS**



**INCLUDED**  
**cod. KEE00468**  
Handset control € --,--



**cod. LEM-067**  
Foot pedal control € 156,00



OR

**cod. LEM-180**  
Wireless foot pedal control (NO foot pedal with cable NO remote control) € 219,00

**MATTRESS**



**INCLUDED**

**cod. 994**  
Standard mattress € --,--



**cod. 996**  
Anatomic Bi-Zak mattress € 208,00



**cod. 1000**  
Extra comfort mattress with Memory Foam 15cm € 271,00



**cod. XL 70**  
Mattress XL 70cm € 271,00

**SINGLE STITCH (tone on tone)** STANDARD  
**DOUBLE STITCH (contrasting white or brown)** OPTIONAL  
**NO STITCHES** OPTIONAL

**SEAT**



**INCLUDED**

**cod. 959**  
Fixed seat € --,--



**cod. ROT**  
Seat with 180° rotation € 156,00

**ELECTRIC SYSTEM**



**INCLUDED**

**cod. KEE00462**  
EU Cable 230V € --,--



**cod. KEE00463**  
UK Cable 230V € --,--



**cod. KEE00465**  
USA Cable 110V € --,--



**cod. KEE00464**  
Australian Cable 240V € --,--

**ACCESSORIES UPON REQUEST**



**cod. 208M**  
Flat armrest couple € 260,00



**cod. 111-P**  
Small Zak headrest € 198,00



**cod. 182**  
Anto head rest for hair transplantation € 281,00



**cod. 183**  
Strip headrest with face hole € 271,00



**cod. 108 / 108 XL**  
Roll holder (66 / 75 cm) € 41,00



**cod. PROT.GAMBE BIZAK**  
Plastic leg protection € 48,00



**cod. LEM-139**  
Wheels with brake (ø 50 mm) € 18,00 ea.



**cod. 334 / cod. 334 XL**  
Seat guides couple / Seat guides couple XL € 198,00



**cod. 335 / cod. 335 XL**  
Back guides couple / Back guides couple XL € 198,00



**cod. 315**  
Curtain holder (fixed with rotating clamp and guides on the seat) € 57,00



**cod. 345**  
Fixed clamp € 91,00











**cod. 346**  
Rotating clamp € 91,00

MANDATORY

UPON REQUEST

## ACCESSORIES UPON REQUEST

	<b>cod. 311</b> I.V. Rod (fixed with rotating clamp and guides on the back)	€ 94,00		<b>cod. 1024</b> Hemo foot support	€ 115,00
	<b>cod. 313</b> Medical armrest couple (to be fixed with rotating clamp and guides on the back)	€ 281,00		<b>cod. 318</b> Thigh supports couple (fixed with flx clamp and guides on the seat)	€ 448,00
	<b>cod. 1162</b> Blood sample taking armrest couple (fixed with flx clamp and guides on the seat)	€ 458,00		<b>cod. 354 NEW</b> Inox tray with support (fixed with flx clamp and guides on the seat)	€ 198,00
	<b>cod. LEM-151</b> Heel support couple (fixed with flx clamp and guides on the seat)	€ 448,00		<b>cod. LOGO</b> Customized mattress with logo	€ 136,00
	<b>cod. NO CUCITURE</b> Option for mattress without stitching	€ --,--			

cod. 963

# LEMI SYNCRO BI-ZAK

Electrically adjustable chair

### Included:

- 3 motors (height, Trendelenburg, back/leg)
- Synchronized back/leg movement
- Adjustable headrest and footrest
- Flat mattress
- Foot pedal control with automatic function



**Size**  
190x62x62/92h cm  
74,8x24,4x24,4/36,2h"

**Packing (ea. carton)**  
170x74x86h cm  
66,9x29,1x33,8h"

**Weight (packed)**  
83 Kg

### FRAME COLORS



White

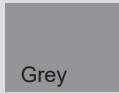

Grey

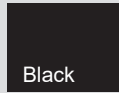

Black

Base Price: € 2.750,00

### CONTROLS



INCLUDED

cod. LEM-070  
Foot pedal control € --,--

OR

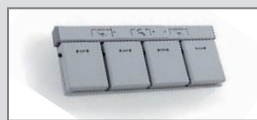

cod. LEM-179  
Wireless foot pedal control (NO foot pedal with cable NO remote control) € 219,00



cod. KEE00494  
Handset Control € 91,00

### MATTRESS



INCLUDED

cod. 994  
Standard mattress € --,--



cod. 996  
Anatomic Bi-Zak mattress € 208,00



cod. 1000  
Extra comfort mattress with Memory Foam 15cm € 271,00

SINGLE STITCH (tone on tone) STANDARD

DOUBLE STITCH (contrasting white or brown) OPTIONAL

NO STITCHES OPTIONAL



cod. XL 70  
Mattress XL 70cm € 271,00

### SEAT



INCLUDED

cod. 959  
Fixed seat € --,--



cod. ROT  
Seat with 180° rotation € 156,00

### ELECTRIC SYSTEM



INCLUDED

cod. KEE00462  
EU Cable 230V € --,--



cod. KEE00463  
UK Cable 230V € --,--



cod. KEE00465  
USA Cable 110V € --,--



cod. KEE00464  
Australian Cable 240V € --,--

### ACCESSORIES UPON REQUEST



cod. 208M  
Flat armrest couple € 260,00



cod. LEM-139  
Wheels with brake (ø 50 mm) € 18,00 ea.



cod. 111-P  
Small Zak headrest € 198,00



cod. 334 / cod. 334 XL  
Seat guides couple / Seat guides couple XL € 198,00



cod. 182  
Anto head rest for hair transplantation € 281,00



cod. 335 / cod. 335 XL  
Back guides couple / Back guides couple XL € 198,00



cod. 183  
Strip headrest with face hole € 271,00



cod. 315  
Curtain holder (fixed with rotating clamp and guides on the seat) € 57,00



cod. 108 / 108 XL  
Roll holder (66 / 75 cm) € 41,00



cod. 345  
Fixed clamp € 91,00



cod. PROT.GAMBE BIZAK  
Plastic leg protection € 48,00











cod. 346  
Rotating clamp € 91,00

MANDATORY

UPON REQUEST

## ACCESSORIES UPON REQUEST

	<b>cod. 311</b> I.V. Rod (fixed with rotating clamp and guides on the back)	€ 94,00		<b>cod. 1024</b> Hemo foot support	€ 115,00
	<b>cod. 313</b> Medical armrest couple (to be fixed with rotating clamp and guides on the back)	€ 281,00		<b>cod. 318</b> Thigh supports couple (fixed with flx clamp and guides on the seat)	€ 448,00
	<b>cod. 1162</b> Blood sample taking armrest couple (fixed with flx clamp and guides on the seat)	€ 458,00		<b>cod. 354 NEW</b> Inox tray with support (fixed with flx clamp and guides on the seat)	€ 198,00
	<b>cod. LEM-151</b> Heel support couple (fixed with flx clamp and guides on the seat)	€ 448,00		<b>cod. LOGO</b> Customized mattress with logo	€ 136,00
	<b>cod. NO CUCITURE</b> Option for mattress without stitching	€ --,--			



**Size**  
190x62x62/92h cm  
74,8x24,4x24,4/36,2h"

**Packing (ea. carton)**  
170x74x86h cm  
66,9x29,1x33,8h"

**Weight (packed)**  
74 Kg

## cod. 967 LEMI 3

Chair with electric height adjustment

### Included:

- 1 motor (height)
- Manual back rest, leg rest and Trendelenburg adjustment
- Flat mattress
- Foot pedal control

### FRAME COLORS



Base Price: € 2.320,00

### CONTROLS



INCLUDED

cod. LEM-069  
Foot pedal control € --,--

### MATTRESS



INCLUDED  
cod. 990  
Standard mattress € --,--



cod. 109  
Anatomic mattress € 208,00



cod. XL 70  
Mattress XL 70cm € 271,00



cod. 100  
Extra comfort mattress  
with Memory Foam 15cm € 271,00

SINGLE STITCH (tone on tone) STANDARD  
DOUBLE STITCH (contrasting white or brown) OPTIONAL  
NO STITCHES OPTIONAL

### SEAT



INCLUDED  
cod. 958  
Fixed seat € --,--



cod. ROT MAN  
Seat with 180° rotation € 156,00

### ELECTRIC SYSTEM



INCLUDED  
cod. KEE00462  
EU Cable 230V € --,--



cod. KEE00465  
USA Cable 110V € --,--



cod. KEE00463  
UK Cable 230V € --,--



cod. KEE00464  
Australian Cable 240V € --,--

### ACCESSORIES UPON REQUEST



cod. 208M  
Flat armrest couple € 260,00



cod. 114 P  
Mattress protection with polyurethane € 90,00



cod. 108 / 108 XL  
Roll holder (66 / 75 cm) € 41,00



cod. PROT.GAMBE  
Plastic leg protection € 48,00



cod. LEM-139  
Wheels with brake (ø 50 mm) € 18,00 ea.



cod. 315  
Curtain holder  
(fixed with rotating clamp and guides on the seat) € 57,00



cod. 334 / cod. 334 XL  
Seat guides couple / Seat guides couple XL € 198,00



cod. 335 / cod. 335 XL  
Back guides couple / Back guides couple XL € 198,00



cod. 311  
I.V. Rod  
(fixed with rotating clamp and guides on the back) € 94,00



cod. 354 NEW  
Inox tray with support  
(fixed with fix clamp and guides on the seat) € 198,00



cod. 345  
Fixed clamp € 91,00



cod. 346  
Rotating clamp € 91,00

MANDATORY

UPON REQUEST

## ACCESSORIES UPON REQUEST

	<b>cod. 313</b> Medical armrest couple (to be fixed with rotating clamp and guides on the back)	<b>€ 281,00</b>		<b>cod. 318</b> Thigh supports couple (fixed with flx clamp and guides on the seat)	<b>€ 448,00</b>
	<b>cod. 1162</b> Blood sample taking armrest couple (fixed with flx clamp and guides on the seat)	<b>€ 458,00</b>		<b>cod. NO CUCITURE</b> Option for mattress without stitching	<b>€ --,--</b>
	<b>cod. LEM-151</b> Heel support couple (fixed with flx clamp and guides on the seat)	<b>€ 448,00</b>		<b>cod. LOGO</b> Customized mattress with logo	<b>€ 136,00</b>



**Size**  
190x62x62/92h cm  
74,8x24,4x24,4/36,2h"

**Packing (ea. carton)**  
170x74x86h cm  
66,9x29,1x33,8h"

**Weight (packed)**  
73 Kg

cod. 975

# LEMI 3 BI-ZAK

Chair with electric height adjustment

**Included:**

- 1 motor (height)
- Manual back rest, leg rest and Trendelenburg adjustment
- BI-ZAK mattress
- Foot pedal control

Base Price: € 2.420,00

**FRAME COLORS**



White

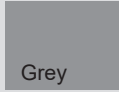

Grey



Black

**CONTROLS**



**INCLUDED**

cod. LEM-069  
Foot pedal control € --,--

**MATTRESS**



**INCLUDED**

cod. 994  
Standard mattress € --,--



cod. 996  
Anatomic Bi-Zak mattress € 208,00



cod. 1000  
Extra comfort mattress with Memory Foam 15cm € 271,00

**SINGLE STITCH (tone on tone)** STANDARD  
**DOUBLE STITCH (contrasting white or brown)** OPTIONAL  
**NO STITCHES** OPTIONAL



cod. XL 70  
Mattress XL 70cm € 271,00

**SEAT**



**INCLUDED**

cod. 958  
Fixed seat € --,--



cod. ROT MAN  
Seat with 180° rotation € 156,00

**ELECTRIC SYSTEM**



**INCLUDED**

cod. KEE00462  
EU Cable 230V € --,--



cod. KEE00465  
USA Cable 110V € --,--



cod. KEE00463  
UK Cable 230V € --,--



cod. KEE00464  
Australian Cable 240V € --,--

**ACCESSORIES UPON REQUEST**



cod. 208M  
Flat armrest couple € 260,00



cod. 111-P  
Small Zak headrest € 198,00



cod. 182  
Anto head rest for hair transplantation € 281,00



cod. 183  
Strip headrest with face hole € 271,00



cod. 108 / 108 XL  
Roll holder (66 / 75 cm) € 41,00



cod. PROT.GAMBE BIZAK  
Plastic leg protection € 48,00



cod. LEM-139  
Wheels with brake (ø 50 mm) € 18,00 ea.



cod. 334 / cod. 334 XL  
Seat guides couple / Seat guides couple XL € 198,00



cod. 335 / cod. 335 XL  
Back guides couple / Back guides couple XL € 198,00



cod. 315  
Curtain holder € 57,00  
(fixed with rotating clamp and guides on the seat)



cod. 345  
Fixed clamp € 91,00











cod. 346  
Rotating clamp € 91,00

MANDATORY

UPON REQUEST

## ACCESSORIES UPON REQUEST

	<b>cod. 311</b> I.V. Rod (fixed with rotating clamp and guides on the back)	€ 94,00		<b>cod. 1024</b> Hemo foot support	€ 115,00
	<b>cod. 313</b> Medical armrest couple (to be fixed with rotating clamp and guides on the back)	€ 281,00		<b>cod. 318</b> Thigh supports couple (fixed with flx clamp and guides on the seat)	€ 448,00
	<b>cod. 1162</b> Blood sample taking armrest couple (fixed with flx clamp and guides on the seat)	€ 458,00		<b>cod. 354 NEW</b> Inox tray with support (fixed with flx clamp and guides on the seat)	€ 198,00
	<b>cod. LEM-151</b> Heel support couple (fixed with flx clamp and guides on the seat)	€ 448,00		<b>cod. LOGO</b> Customized mattress with logo	€ 136,00
	<b>cod. NO CUCITURE</b> Option for mattress without stitching	€ --,--			



cod. 946

# LEMI 2

Chair with hydraulic height adjustment

### Included:

- Height adjustment by oleodynamic pump
- Manually adjustable back, leg and trendelenburg
- Rotation 360°
- Flat mattress

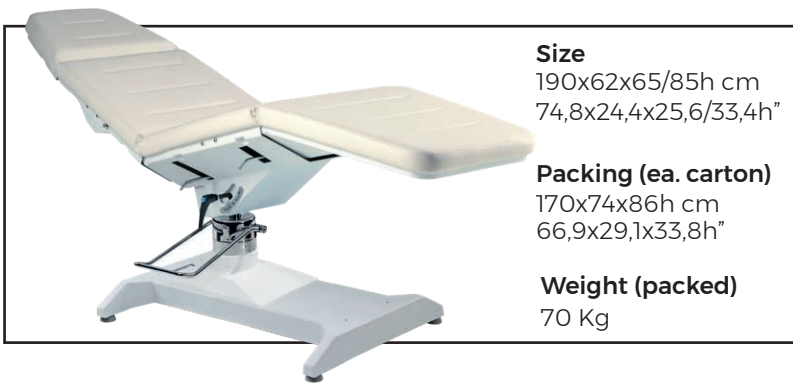

**Size**  
190x62x65/85h cm  
74,8x24,4x25,6/33,4h"

**Packing (ea. carton)**  
170x74x86h cm  
66,9x29,1x33,8h"

**Weight (packed)**  
70 Kg

### FRAME COLORS

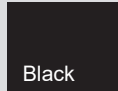
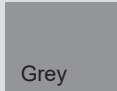

Base Price: € 1.730,00

### SEAT



#### INCLUDED

**cod. ROT**  
Seat with 360° rotation € --,--

### MATTRESS



#### INCLUDED

**cod. 990**  
Standard mattress € --,--



**cod. 109**  
Anatomic mattress € 208,00



**cod. XL 70**  
Mattress XL 70cm € 271,00



**cod. 100**  
Extra comfort mattress with Memory Foam 15cm € 271,00

SINGLE STITCH (tone on tone) STANDARD  
DOUBLE STITCH (contrasting white or brown) OPTIONAL  
NO STITCHES OPTIONAL

### ACCESSORIES UPON REQUEST



**cod. 208M**  
Flat armrest couple € 260,00



**cod. 334 / cod. 334 XL**  
Seat guides couple / Seat guides couple XL € 198,00



**cod. 114 P**  
Mattress protection with polyurethane € 90,00



**cod. 335 / cod. 335 XL**  
Back guides couple / Back guides couple XL € 198,00



**cod. 108 / 108 XL**  
Roll holder (66 / 75 cm) € 41,00



**cod. 318**  
Thigh supports couple (fixed with flx clamp and guides on the seat) € 448,00



**cod. PROT.GAMBE**  
Plastic leg protection € 48,00



**cod. 1162**  
Blood sample taking armrest couple (fixed with flx clamp and guides on the seat) € 458,00



**cod. LEM-139**  
Wheels with brake (ø 50 mm) € 18,00 ea.



**cod. 354 NEW**  
Inox tray with support (fixed with flx clamp and guides on the seat) € 198,00



**cod. 315**  
Curtain holder (fixed with rotating clamp and guides on the seat) € 57,00



**cod. 313**  
Medical armrest couple (to be fixed with rotating clamp and guides on the back) € 281,00



**cod. 311**  
I.V. Rod (fixed with rotating clamp and guides on the back) € 94,00



**cod. LEM-151**  
Heel support couple (fixed with flx clamp and guides on the seat) € 448,00



**cod. 345**  
Fixed clamp € 91,00



**cod. NO CUCITURE**  
Option for mattress without stitching € --,--



**cod. 346**  
Rotating clamp € 91,00



**cod. LOGO**  
Customized mattress with logo € 136,00

MANDATORY

UPON REQUEST

cod. 955

# LEMI 2 BI-ZAK

Chair with hydraulic height adjustment

## Included:

- Height adjustment by oleodynamic pump
- Manually adjustable back, leg and trendelenburg
- Rotation 360°
- BI-ZAK mattress

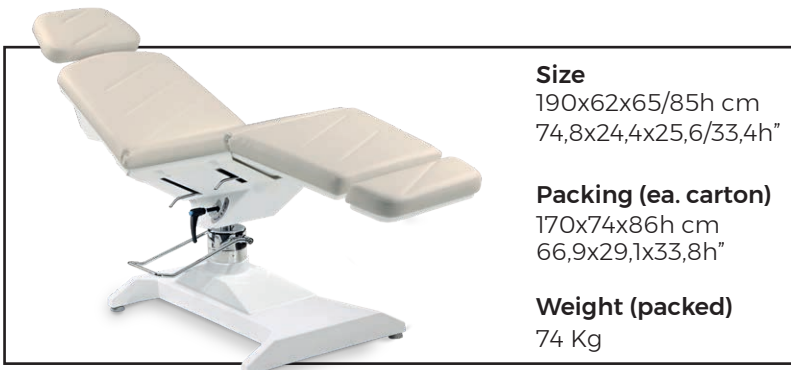

**Size**  
190x62x65/85h cm  
74,8x24,4x25,6/33,4h"

**Packing (ea. carton)**  
170x74x86h cm  
66,9x29,1x33,8h"

**Weight (packed)**  
74 Kg

## FRAME COLORS

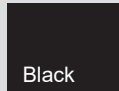
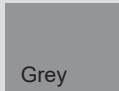
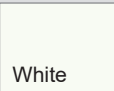

Base Price: € 1.820,00

## SEAT



### INCLUDED

**cod. ROT**  
Seat with 360° rotation € --,--

## MATTRESS



### INCLUDED

**cod. 994**  
Standard mattress € --,--



**cod. XL 70**  
Mattress XL 70cm € 271,00



**cod. 996**  
Anatomic Bi-Zak mattress € 208,00



**cod. 1000**  
Extra comfort mattress with Memory Foam 15cm € 271,00

SINGLE STITCH (tone on tone) STANDARD  
DOUBLE STITCH (contrasting white or brown) OPTIONAL  
NO STITCHES OPTIONAL

## ACCESSORIES UPON REQUEST



**cod. 208M**  
Flat armrest couple € 260,00



**cod. 334 / cod. 334 XL**  
Seat guides couple / Seat guides couple XL € 198,00



**cod. 111-P**  
Small Zak headrest € 198,00



**cod. 335 / cod. 335 XL**  
Back guides couple / Back guides couple XL € 198,00



**cod. 182**  
Anto head rest for hair transplantation € 281,00



**cod. 315**  
Curtain holder (fixed with rotating clamp and guides on the seat) € 57,00



**cod. 183**  
Strip headrest with face hole € 271,00



**cod. 345**  
Fixed clamp € 91,00



**cod. 108 / 108 XL**  
Roll holder (66 / 75 cm) € 41,00



**cod. 346**  
Rotating clamp € 91,00



**cod. PROT.GAMBE BIZAK**  
Plastic leg protection € 48,00



**cod. 1024**  
Hemo foot support € 115,00



**cod. 311**  
I.V. Rod (fixed with rotating clamp and guides on the back) € 94,00



**cod. 318**  
Thigh supports couple (fixed with flx clamp and guides on the seat) € 448,00



**cod. 313**  
Medical armrest couple (to be fixed with rotating clamp and guides on the back) € 281,00



**cod. 354 NEW**  
Inox tray with support (fixed with flx clamp and guides on the seat) € 198,00



**cod. 1162**  
Blood sample taking armrest couple (fixed with flx clamp and guides on the seat) € 458,00



**cod. NO CUCITURE**  
Option for mattress without stitching € --,--



**cod. LEM-151**  
Heel support couple (fixed with flx clamp and guides on the seat) € 448,00



**cod. LOGO**  
Customized mattress with logo € 136,00



**cod. LEM-139**  
Wheels with brake (ø 50 mm) € 18,00 ea.

MANDATORY

UPON REQUEST

cod. 969

# TESERA 4M

Chair with electric height adjustment

### Included:

- 4 motors (height, trendelenburg, leg rest, back rest)
- Anatomic Bi-Zak mattress without stiches
- Handset control with automatic function

Base Price: € 3.140,00

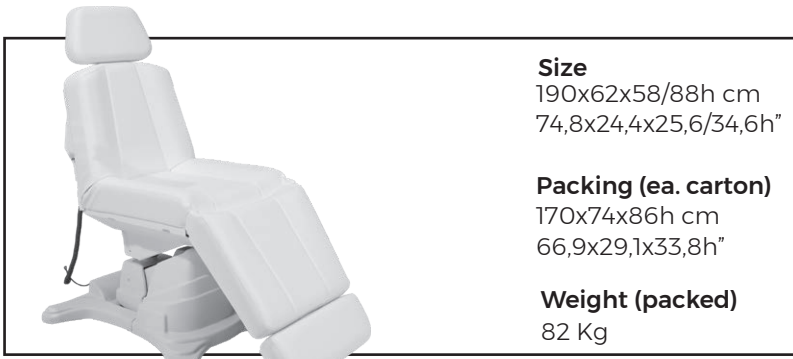

**Size**  
190x62x58/88h cm  
74,8x24,4x25,6/34,6h"

**Packing (ea. carton)**  
170x74x86h cm  
66,9x29,1x33,8h"

**Weight (packed)**  
82 Kg

### FRAME COLORS



### CONTROLS



INCLUDED

cod. KEE00468 € --,--  
Handset control



cod. LEM-067 € 156,00  
Foot pedal control



OR

cod. LEM-180 € 219,00  
Wireless foot pedal control (NO foot pedal with cable NO remote control)

### MATTRESS



INCLUDED

cod. 996 € --,--  
Anatomic Bi-Zak mattress without stitching



cod. 1000 € 271,00  
Extra comfort mattress with Memory Foam 15cm



cod. XL € 271,00  
Mattress XL 70 cm

SINGLE STITCH (tone on tone) STANDARD  
DOUBLE STITCH (contrasting white or brown) OPTIONAL  
NO STITCHES OPTIONAL

### SEAT



INCLUDED

cod. 1028 € --,--  
Fixed seat



cod. ROT TES € 156,00  
Seat with 180° rotation

### ELECTRIC SYSTEM



INCLUDED

cod. KEE00462 € --,--  
EU Cable 230V



cod. KEE00463 € --,--  
UK Cable 230V



cod. KEE00465 € --,--  
USA Cable 110V



cod. KEE00464 € --,--  
Australian Cable 240V

### ACCESSORIES UPON REQUEST



cod. 208M € 260,00  
Flat armrest couple



cod. 108 / 108 XL € 41,00  
Roll holder (66 / 75 cm)



cod. PROT.GAMBE BIZAK € 48,00  
Plastic leg protection



cod. LEM-139 € 18,00 ea.  
Wheels with brake (ø 50 mm)



cod. 315 € 57,00  
Curtain holder (fixed with rotating clamp and guides on the seat)



cod. 311 € 94,00  
I.V. Rod (fixed with rotating clamp and guides on the back)



cod. 354 NEW € 198,00  
Inox tray with support (fixed with flx clamp and guides on the seat)



cod. 345 € 91,00  
Fixed clamp



cod. 346 € 91,00  
Rotating clamp



cod. 334 / cod. 334 XL € 198,00  
Seat guides couple / Seat guides couple XL



cod. 335 / cod. 335 XL € 198,00  
Back guides couple / Back guides couple XL











cod. LEM-151 € 448,00  
Heel support couple (fixed with flx clamp and guides on the seat)

MANDATORY

UPON REQUEST

## ACCESSORIES UPON REQUEST

	<b>cod. 183</b> Strip headrest with face hole	€ 271,00		<b>cod. 1024</b> Hemo foot support	€ 115,00
	<b>cod. 111-P</b> Small Zak headrest	€ 198,00		<b>cod. 1162</b> Blood sample taking armrest couple (fixed with fix clamp and guides on the seat)	€ 458,00
	<b>cod. 182</b> Anto head rest for hair transplantation	€ 281,00		<b>cod. 313</b> Medical armrest couple (to be fixed with rotating clamp and guides on the back)	€ 281,00
	<b>cod. 318</b> Thigh supports couple (fixed with fix clamp and guides on the seat)	€ 448,00		<b>cod. LOGO</b> Customized mattress with logo	€ 136,00



**Size**  
190x62x62/92h cm  
74,8x24,4x24,4/36,2h"

**Packing (ea. carton)**  
170x74x86h cm  
66,9x29,1x33,8h"

**Weight (packed)**  
82 Kg

## cod. 303 LEMI MED

Electrically adjustable chair

### Included:

- 4 motors (height, back, leg and trendelenburg)
- Anatomic Bi-Zak mattress
- Seat guides couple
- Back guides couple
- Roll holder
- Foot pedal control with AUT function

### FRAME COLORS

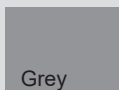
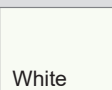

Base Price: € 3.540,00

### CONTROLS



**cod. LEM-067**  
Foot pedal control € --,--

or

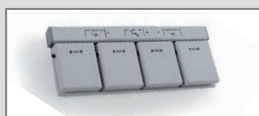

**cod. LEM-180**  
Wireless foot pedal control (NO foot pedal with cable NO remote control) € 219,00



**cod. KEE00468**  
Handset Control € 91,00

### MATTRESS



**INCLUDED**

**cod. 996**  
Anatomic Bi-Zak mattress € --,--

### SEAT



**INCLUDED**

**cod. 959**  
Fixed seat € --,--



**cod. ROT**  
Seat with 180° rotation € 156,00

### ELECTRIC SYSTEM



**INCLUDED**

**cod. KEE00462**  
EU Cable 230V € --,--



**cod. KEE00463**  
UK Cable 230V € --,--



**cod. KEE00465**  
USA Cable 110V € --,--



**cod. KEE00464**  
Australian Cable 240V € --,--

### ACCESSORIES UPON REQUEST



**cod. 311**  
I.V. Rod € 94,00  
(fixed with rotating clamp and guides on the back)



**cod. 345**  
Fixed clamp € 91,00



**cod. 346**  
Rotating clamp € 91,00



**cod. 313**  
Medical armrest couple € 281,00  
(to be fixed with rotating clamp and guides on the back)



**cod. 1162**  
Blood sample taking armrest couple € 458,00  
(fixed with flx clamp and guides on the seat)



**cod. LEM-151**  
Heel support couple € 448,00  
(fixed with flx clamp and guides on the seat)



**cod. 318**  
Thigh supports couple € 448,00  
(fixed with flx clamp and guides on the seat)



**cod. 315**  
Curtain holder € 57,00  
(fixed with rotating clamp and guides on the seat)



**cod. NO CUCITURE**  
Option for mattress without stitching € --,--



**cod. 182**  
Anto head rest for hair transplantation € 281,00



**cod. 183**  
Strip headrest with face hole € 271,00



**cod. 111-P**  
Small Zak headrest € 198,00



**cod. PROT.GAMBE**  
Plastic leg protection € 48,00



**cod. LEM-139**  
Wheels with brake (ø 50 mm) € 18,00 ea.



**cod. 354 NEW**  
Inox tray with support € 198,00  
(fixed with flx clamp and guides on the seat)



**cod. 1024**  
Hemo foot support € 115,00



**cod. LOGO**  
Customized mattress with logo € 136,00

MANDATORY

UPON REQUEST

# LEMI MED for HEMODIALYSIS / BLOOD SAMPLING



LEMI MED + Blood sample taking armrest couple + Fixed clamps (x2) + Hemo foot support + I.V. ROD + Rotating clamp (x1)





EXAMPLE OF HEMODIALYSIS / BLOOD SAMPLING CONFIGURATION

## RECOMMENDED ACCESSORIES

Base Price Lemi Med: € 3.540,00

	<b>cod. 311</b> I.V. Rod (fixed with rotating clamp and guides on the back)	€ 94,00
	<b>cod. 345</b> Fixed clamp	€ 91,00
	<b>cod. 346</b> Rotating clamp	€ 91,00

	<b>cod. 1162</b> Blood sample taking armrest couple (fixed with fix clamp and guides on the seat)	€ 458,00
	<b>cod. 1024</b> Hemo foot support	€ 115,00

Total Configuration Price: € 4.480,00

ACCESSORIES

# LEMI MED for GYNECOLOGY

LEMI MED + Thigh support couple + Inox tray with support + Fixed clamps (x3)



EXAMPLE OF GYNECOLOGY CONFIGURATION

## RECOMMENDED ACCESSORIES

Base Price Lemi Med: € 3.540,00

	<b>cod. 318</b> Thigh supports couple (fixed with fix clamp and guides on the seat)	€ 448,00
--	---	----------

OR

	<b>cod. LEM-151</b> Heel support couple (fixed with fix clamp and guides on the seat)	€ 448,00
--	---	----------

	<b>cod. 345</b> Fixed clamp	€ 91,00
---	--------------------------------	---------

	<b>cod. 354 NEW</b> Inox tray with support (fixed with fix clamp and guides on the seat)	€ 198,00
---	--	----------

ACCESSORIES

Total Configuration Price: € 4.368,00



**Size**  
168x59x126h cm  
66,5x23,2x49,6h"

**Packing (ea. carton)**  
170x74x86h cm  
66,9x29,1x33,8h"

**Weight (packed)**  
64 Kg

cod. 172

# HE-MOVE

Electrically adjustable chair for blood sample

**Incluso:**

- 2 electric motors for back and trendelenburg adjustment
- Seat guides couple
- Blood sampling armrests (cod. 1180)
- Fixed clamps
- Roll holder
- Rolling wheels with brake

**FRAME COLORS**

Grey

Base Price: € 3.180,00

**CONTROLS**



INCLUDED

cod. SWC 23  
Handset control € --,--

**MATTRESS**



INCLUDED

cod. 117-M  
Standard mattress € --,--

**ELECTRIC SYSTEM**



INCLUDED

cod. KEE00585  
EU Cable 230V € --,--



cod. -  
UK Cable 230V € --,--



cod. KEE00577  
USA Cable 110V € --,--



cod. -  
Australian Cable 240V € --,--

**ACCESSORIES UPON REQUEST**



cod. 311  
I.V. Rod  
(to be fixed with support) € 94,00



cod. 335CK  
Back guides couple € 198,00



cod. 346  
Rotating clamp € 91,00



cod. PROT.DREAMED  
Plastic leg protection € 48,00



cod. 354 NEW  
Inox tray with support  
(fixed with fix clamp and guides on the seat) € 198,00



cod. LOGO  
Customized mattress with logo € 136,00

MANDATORY

UPON REQUEST





**Size**  
194x90x62h cm  
76,3x35,4x24,4h"

**Packing (ea. carton)**  
170x74x86h cm  
66,9x29,1x33,8h"

**Weight (packed)**  
68 Kg

cod. 116

# KE-TREAT

Electrically adjustable chair specific for chemotherapy

**Included:**

- 3 motors (back, leg and trendelenburg)
- Back guides couple
- Medical armrest couple (cod. 300)
- Rotating clamps couple
- Extra comfort memory foam mattress.
- Removable footrest
- Rolling wheels with brake
- Handset control

**FRAME COLORS**

Grey

Base Price: € 2.940,00

**CONTROLS**



INCLUDED

cod. SWC 23  
Handset control € --,--

**MATTRESS**



INCLUDED

cod. 116-M  
Extra Soft mattress  
without stitching € --,--

**SEAT**



INCLUDED

cod. 959  
Fixed seat € --,--

**ELECTRIC SYSTEM**



INCLUDED

cod. KEE00585  
EU Cable 230V € --,--



cod. -  
UK Cable 230V € --,--



cod. KEE00577  
USA Cable 110V € --,--



cod. -  
Australian Cable 240V € --,--

**ACCESSORIES UPON REQUEST**



cod. 311  
I.V. Rod € 94,00  
(to be fixed with support)



cod. 874  
Support for I.V. Rod € 43,00



cod. 345  
Fixed clamp € 91,00



cod. 346  
Rotating clamp € 91,00



cod. 315  
Curtain holder € 57,00  
(fixed with rotating clamp and guides on the seat)



cod. 354 NEW  
Inox tray with support € 198,00  
(fixed with fix clamp and guides on the seat)



cod. 108  
Roll holder € 41,00



cod. 334 CK  
Seat guides couple € 198,00



cod. PROT.GAMBE BIZAK  
Plastic leg protection € 48,00



cod. LOGO  
Customized mattress with logo € 136,00

MANDATORY

UPON REQUEST



**Size**  
165x72x52/82h cm  
64,9x28,3x20,4/32,2h"

**Packing (ea. carton)**  
170x74x86h cm  
66,9x29,1x33,8h"

**Weight (packed)**  
82 Kg

cod. 333

# DREAMED 4M

Chair with electric adjustment for ENT, dentistry, ophthalmology and diagnostics

**Included:**

- 4 motors (height, back, leg and trendelenburg)
- Medical predisposition for backrest guides
- Headrest cushion
- Rotation 180°
- Foot pedal control with AUT function

**FRAME COLORS**

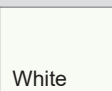

White

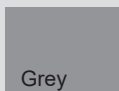

Grey

Base Price: € 3.610,00

**CONTROLS**



**INCLUDED**

cod. LEM-067  
Foot pedal control € --,--

or



cod. LEM-180  
Wireless foot pedal control (NO foot pedal with cable NO remote control) € 219,00



cod. KEE00468  
Handset Control € 91,00

**ELECTRIC SYSTEM**



**INCLUDED**

cod. KEE00462  
EU Cable 230V € --,--



cod. KEE00465  
USA Cable 110V € --,--



cod. KEE00464  
Australian Cable 240V € --,--



cod. KEE00463  
UK Cable 230V € --,--

**MATTRESS**



**INCLUDED**

cod. 211  
Standard mattress € --,--

**ACCESSORIES UPON REQUEST**

	cod. 345 Fixed clamp	€ 91,00		cod. 354 NEW Inox tray with support (fixed with flx clamp and guides on the seat)	€ 198,00
	cod. 346 Rotating clamp	€ 91,00		cod. 315 Curtain holder (fixed with rotating clamp and guides on the seat)	€ 57,00
	cod. 334 Seat guides couple	€ 198,00		cod. 311 I.V. Rod (fixed with rotating clamp and guides on the back)	€ 94,00
	cod. 335CK Back guides couple	€ 198,00		cod. 108 Roll holder	€ 41,00
	cod. 208 Flat automatic armrest couple	€ 260,00		cod. LEM-139 Wheels with brake (ø 50 mm)	€ 18,00 ea.
	cod. 313 Medical armrest couple (to be fixed with rotating clamp and guides on the back)	€ 281,00		cod. PROT.DREAMED Plastic leg protection	€ 48,00
	cod. 1162 Blood sample taking armrest couple (fixed with flx clamp and guides on the seat)	€ 458,00		cod. PROT. TESTA Plastic protection for head support	€ 22,00
	cod. LEM-151 Heel support couple (fixed with flx clamp and guides on the seat)	€ 448,00		cod. LOGO Customized mattress with logo	€ 136,00
	cod. 318 Thigh supports couple (fixed with flx clamp and guides on the seat)	€ 448,00			

MANDATORY

UPON REQUEST



**Size**  
165x73x52/82h cm  
64,9x28,7x20,4/32,2h"

**Packing (ea. carton)**  
124x80x77h cm  
48,8x31,4x30,3h"

**Weight (packed)**  
85 Kg

## cod. 333 MOVE DREAMED 4M MOVE

Chair with electric adjustment for ENT, dentistry, ophthalmology and diagnostics

### Included:

- 4 motors (height, back, leg and trendelenburg)
- Medical predisposition for backrest guides
- Headrest cushion
- Rolling wheels
- Foot pedal control with AUT function
- **Rotation NOT available**

### FRAME COLORS

Grey

Base Price: € 3.930,00

### CONTROLS



INCLUDED

cod. LEM-067  
Foot pedal control € --,--

or



cod. LEM-180  
Wireless foot pedal control (NO foot pedal with cable NO remote control) € 219,00



cod. KEE00468  
Handset Control € 91,00

### ELECTRIC SYSTEM

INCLUDED



cod. KEE00462  
EU Cable 230V € --,--



cod. KEE00465  
USA Cable 110V € --,--



cod. KEE00464  
Australian Cable 240V € --,--



cod. KEE00463  
UK Cable 230V € --,--

### MATTRESS



INCLUDED

cod. 211  
Standard mattress € --,--

### ACCESSORIES UPON REQUEST



cod. 345  
Fixed clamp € 91,00



cod. 346  
Rotating clamp € 91,00



cod. 334  
Seat guides couple € 198,00



cod. 335CK  
Back guides couple € 198,00



cod. 208  
Flat automatic armrest couple € 260,00



cod. 313  
Medical armrest couple (to be fixed with rotating clamp and guides on the back) € 281,00



cod. 1162  
Blood sample taking armrest couple (fixed with flx clamp and guides on the seat) € 458,00



cod. LEM-151  
Heel support couple (fixed with flx clamp and guides on the seat) € 448,00



cod. 318  
Thigh supports couple (fixed with flx clamp and guides on the seat) € 448,00



cod. 354 NEW  
Inox tray with support (fixed with flx clamp and guides on the seat) € 198,00



cod. 315  
Curtain holder (fixed with rotating clamp and guides on the seat) € 57,00



cod. 311  
I.V. Rod (fixed with rotating clamp and guides on the back) € 94,00



cod. 108  
Roll holder € 41,00



cod. PROT.DREAMED  
Plastic leg protection € 48,00



PROT. TESTA  
cod. PROT. TESTA  
Plastic protection for head support € 22,00



cod. LOGO  
Customized mattress with logo € 136,00

MANDATORY

UPON REQUEST



**Size**  
159x72x52/82h cm  
62,5x28,3x20,4/32,2h"

**Packing (ea. carton)**  
170x74x86h cm  
66,9x29,1x33,8h"

**Weight (packed)**  
81 Kg

cod. 336

# DREAMED ZAK 4M

Chair with electric adjustment for ENT, dentistry ophthalmology and diagnostics

**Included:**

- 4 motors (height, back leg and trendelenburg)
- Small Zak headrest (adjustable and removable)
- Back guides couple
- Rotation 180°
- Foot pedal control with AUT function

Base Price: € 3.830,00

**FRAME COLORS**

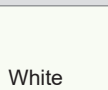

White

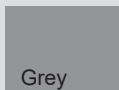

Grey

**CONTROLS**



**INCLUDED**

cod. LEM-067  
Foot pedal control € --,--

or



cod. LEM-180  
Wireless foot pedal control (NO foot pedal with cable NO remote control) € 219,00



cod. KEE00468  
Handset Control € 91,00

**ELECTRIC SYSTEM**



**INCLUDED**

cod. KEE00462  
EU Cable 230V € --,--



cod. KEE00463  
UK Cable 230V € --,--



cod. KEE00465  
USA Cable 110V € --,--



cod. KEE00464  
Australian Cable 240V € --,--

**MATTRESS**



**INCLUDED**

cod. 1011  
Standard Zak mattress € --,--

**ACCESSORIES UPON REQUEST**



cod. 311  
I.V. Rod  
(fixed with rotating clamp and guides on the back) € 94,00



cod. 334  
Seat guides couple € 198,00



cod. 345  
Fixed clamp € 91,00



cod. 346  
Rotating clamp € 91,00



cod. 313  
Medical armrest couple  
(to be fixed with rotating clamp and guides on the back) € 281,00



cod. 182  
Anto head rest for hair transplantation € 281,00



cod. 183  
Strip headrest with face hole € 271,00



cod. 205-T  
Head support € 54,00



cod. 342  
Ophthalmological headrest € 281,00



cod. 108  
Roll holder € 41,00



cod. 1162  
Blood sample taking armrest couple  
(fixed with flx clamp and guides on the seat) € 458,00



cod. LEM-151  
Heel support couple  
(fixed with flx clamp and guides on the seat) € 448,00



cod. 318  
Thigh supports couple  
(fixed with flx clamp and guides on the seat) € 448,00



cod. 315  
Curtain holder  
(fixed with rotating clamp and guides on the seat) € 57,00



cod. PROT.DREAMED  
Plastic leg protection € 48,00



cod. LEM-139  
Wheels with brake (ø 50 mm) € 18,00 ea.



cod. 354 NEW  
Inox tray with support  
(fixed with flx clamp and guides on the seat) € 198,00



cod. LOGO  
Customized mattress with logo € 136,00

MANDATORY

UPON REQUEST



**Size**  
159x73x52/82h cm  
62,5x28,7x20,4/32,2h"

**Packing (ea. carton)**  
124x80x77h cm  
48,8x31,4x30,3h"

**Weight (packed)**  
85 Kg

## cod. 333-111 MOVE DREAMED ZAK 4M MOVE

Chair with electric adjustment for ENT, dentistry ophthalmology and diagnostics

### Included:

- 4 motors (height, back, leg and trendelenburg)
- Zak Headrest
- Rolling wheels
- Back guides couple
- Foot pedal control with AUT function
- **Rotation NOT available**

Base Price: € 4.140,00

### FRAME COLORS

Grey

### CONTROLS



INCLUDED

cod. LEM-067  
Foot pedal control € --,--

or



cod. LEM-180  
Wireless foot pedal control (NO foot pedal with cable NO remote control) € 219,00



cod. KEE00468  
Handset Control € 91,00

### ELECTRIC SYSTEM

INCLUDED



cod. KEE00462  
EU Cable 230V € --,--



cod. KEE00463  
UK Cable 230V € --,--



cod. KEE00465  
USA Cable 110V € --,--



cod. KEE00464  
Australian Cable 240V € --,--

### MATTRESS

INCLUDED



cod. 1011  
Standard Zak mattress € --,--

### ACCESSORIES UPON REQUEST

	cod. 311 I.V. Rod (fixed with rotating clamp and guides on the back)	€ 94,00
	cod. 334 Seat guides couple	€ 198,00
	cod. 345 Fixed clamp	€ 91,00
	cod. 346 Rotating clamp	€ 91,00
	cod. 313 Medical armrest couple (to be fixed with rotating clamp and guides on the back)	€ 281,00
	cod. 182 Anto head rest for hair transplantation	€ 281,00
	cod. 183 Strip headrest with face hole	€ 271,00
	cod. 205-T Head support	€ 54,00
	cod. 342 Ophthalmological headrest	€ 281,00

	cod. 108 Roll holder	€ 41,00
	cod. 1162 Blood sample taking armrest couple (fixed with flx clamp and guides on the seat)	€ 458,00
	cod. LEM-151 Heel support couple (fixed with flx clamp and guides on the seat)	€ 448,00
	cod. 318 Thigh supports couple (fixed with flx clamp and guides on the seat)	€ 448,00
	cod. 315 Curtain holder (fixed with rotating clamp and guides on the seat)	€ 57,00
	cod. PROT.DREAMED Plastic leg protection	€ 48,00
	cod. 354 NEW Inox tray with support (fixed with flx clamp and guides on the seat)	€ 198,00
	cod. LOGO Customized mattress with logo	€ 136,00

MANDATORY

UPON REQUEST



**Size**  
157x72x52/82h cm  
61,8x28,3x20,4/32,2h"

**Packing (ea. carton)**  
170x74x86h cm  
66,9x29,1x33,8h"

**Weight (packed)**  
79 Kg

cod. 340 G DREAM

# DENTAMED

Chair with electric adjustment for ENT and dentistry

**Included:**

- 4 motors (height, back, trendelenburg, leg)
- Back guides
- Small Zak headrest
- Rotation 180°
- Leg bending up to 90°
- Foot pedal control with automatic function

**Base Price: € 3.940,00**

**FRAME COLORS**

Grey

**CONTROLS**

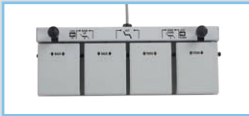

**INCLUDED**

cod. LEM-067  
Foot pedal control € --,--

or



cod. LEM-180  
Wireless foot pedal control (NO foot pedal with cable NO remote control) € 219,00



cod. KEE00468  
Handset Control € 91,00

**ELECTRIC SYSTEM**



**INCLUDED**

cod. KEE00471  
EU Cable 230V € --,--



cod. KEE00472  
UK Cable 230V € --,--



cod. KEE00474  
USA Cable 110V € --,--



cod. KEE00473  
Australian Cable 240V € --,--

**MATTRESS**



**INCLUDED**

cod. 340-M  
Standard Zak mattress € --,--

**ACCESSORIES UPON REQUEST**



cod. 311  
I.V. Rod  
(fixed with rotating clamp and guides on the back) € 94,00



cod. 334  
Seat guides couple € 198,00



cod. 345  
Fixed clamp € 91,00



cod. 346  
Rotating clamp € 91,00



cod. 313  
Medical armrest couple  
(to be fixed with rotating clamp and guides on the back) € 281,00



cod. 182  
Anto head rest for hair transplantation € 281,00



cod. 183  
Strip headrest with face hole € 271,00



cod. 205-T  
Head support € 54,00



cod. 342  
Ophthalmological headrest € 281,00



cod. 108  
Roll holder € 41,00



cod. 1162  
Blood sample taking armrest couple  
(fixed with flx clamp and guides on the seat) € 458,00



cod. LEM-151  
Heel support couple  
(fixed with flx clamp and guides on the seat) € 448,00



cod. 318  
Thigh supports couple  
(fixed with flx clamp and guides on the seat) € 448,00



cod. 315  
Curtain holder  
(fixed with rotating clamp and guides on the seat) € 57,00



cod. PROT.DREAMED  
Plastic leg protection € 48,00



cod. LEM-139  
Wheels with brake (ø 50 mm) € 18,00 ea.



cod. 354 NEW  
Inox tray with support  
(fixed with flx clamp and guides on the seat) € 198,00



cod. LOGO  
Customized mattress with logo € 136,00

MANDATORY

UPON REQUEST

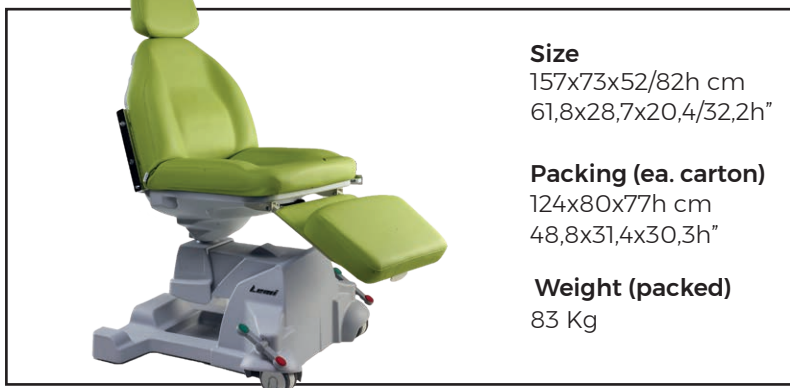

**Size**  
157x73x52/82h cm  
61,8x28,7x20,4/32,2h"

**Packing (ea. carton)**  
124x80x77h cm  
48,8x31,4x30,3h"

**Weight (packed)**  
83 Kg

cod. 340 MOVE  
**DENTAMED MOVE**  
Chair with electric adjustment for ENT and dentistry

**Included:**

- 4 motors (height, back, trendelenburg, leg)
- Back guides couple
- Small Zak headrest
- Rolling wheels
- Foot pedal control with automatic function
- **Rotation NOT available**

Base Price: € 4.250,00

**FRAME COLORS**

Grey

**CONTROLS**



**INCLUDED**

cod. LEM-067  
Foot pedal control € --,--

or



cod. LEM-180  
Wireless foot pedal control (NO foot pedal with cable NO remote control) € 219,00



cod. KEE00468  
Handset Control € 91,00

**ELECTRIC SYSTEM**



**INCLUDED**

cod. KEE00471  
EU Cable 230V € --,--



cod. KEE00472  
UK Cable 230V € --,--



cod. KEE00474  
USA Cable 110V € --,--



cod. KEE00473  
Australian Cable 240V € --,--

**MATTRESS**



**INCLUDED**

cod. 340-M  
Standard Zak mattress € --,--

**ACCESSORIES UPON REQUEST**



cod. 311  
I.V. Rod € 94,00  
(fixed with rotating clamp and guides on the back)



cod. 334  
Seat guides couple € 198,00



cod. 345  
Fixed clamp € 91,00



cod. 346  
Rotating clamp € 91,00



cod. 313  
Medical armrest couple € 281,00  
(to be fixed with rotating clamp and guides on the back)



cod. 182  
Anto head rest for hair transplantation € 281,00



cod. 183  
Strip headrest with face hole € 271,00



cod. 205-T  
Head support € 54,00



cod. 342  
Ophthalmological headrest € 281,00



cod. 108  
Roll holder € 41,00



cod. 1162  
Blood sample taking armrest couple € 458,00  
(fixed with flx clamp and guides on the seat)



cod. LEM-151  
Heel support couple € 448,00  
(fixed with flx clamp and guides on the seat)



cod. 318  
Thigh supports couple € 448,00  
(fixed with flx clamp and guides on the seat)



cod. 315  
Curtain holder € 57,00  
(fixed with rotating clamp and guides on the seat)



cod. PROT.DREAMED  
Plastic leg protection € 48,00



cod. 354 NEW  
Inox tray with support € 198,00  
(fixed with flx clamp and guides on the seat)



cod. LOGO  
Customized mattress with logo € 136,00

MANDATORY

UPON REQUEST



**Size**  
190x80x62/92 cm  
74,8x31,4x24,4/36,2h"

**Packing (ea. carton)**  
170x74x86h cm  
66,9x29,1x33,8h"

**Weight (packed)**  
84 Kg

cod. 195

# HAIR-TECH

Chair fully electric specific for hair transplantation

## Included:

- 4 motors (height, back, legrest, trendelenburg)
- Extra comfort memory foam mattress
- Anto headrest
- Strip headrest
- Adjustable footrest
- Flat armrests
- Handset control with automatic function

## FRAME COLORS



White

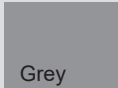

Grey

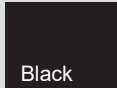

Black

Base Price: € 4.100,00

## CONTROLS



INCLUDED

cod. KEE00468  
Handset control € --,--



cod. LEM-067  
Foot pedal control € 156,00

OR



cod. LEM-180  
Wireless foot pedal control (NO foot pedal with cable NO remote control) € 219,00

## MATTRESS



INCLUDED

cod. 195-M  
Extra Soft mattress without stitching € --,--



cod. 195-M-XL  
Mattress XL € 271,00

## SEAT



INCLUDED

cod. 959  
Fixed seat € --,--



cod. ROT  
Seat with 180° rotation € 156,00

## ELECTRIC SYSTEM



INCLUDED

cod. KEE00462  
EU Cable 230V € --,--



cod. KEE00463  
UK Cable 230V € --,--



cod. KEE00465  
USA Cable 110V € --,--



cod. KEE00464  
Australian Cable 240V € --,--

## ACCESSORIES UPON REQUEST



cod. 334 CK  
Seat guides couple € 198,00



cod. 345  
Fixed clamp € 91,00



cod. 108 / 108 XL  
Roll holder (66 / 75 cm) € 41,00



cod. LEM-139  
Wheels with brake (ø 50 mm) € 18,00 ea.



cod. 354 NEW  
Inox tray with support (fixed with flx clamp and guides on the seat) € 198,00



cod. PROT.GAMBE BIZAK  
Plastic leg protection € 48,00



cod. LOGO  
Customized mattress with logo € 136,00

MANDATORY

UPON REQUEST





**Size**  
170x71x51/102h cm  
66,9x27,9x20/40,1h"

**Packing (ea. carton)**  
170x74x86h cm  
66,9x29,1x33,8h"

**Weight (packed)**  
81 Kg

## cod. 305 GYNO PLUS

Chair for gynaecology and urology with electric adjustment

### Included:

- 3 motors (height, back, trendelenburg)
- Anatomic mattress
- Cushion
- Seat guides couple
- Thigh support couple
- Fixed clamps couple
- Roll holder
- Inox basin for organic waste
- Hand grips couple
- Rotation 180°
- Foot pedal control with AUT function

### FRAME COLORS

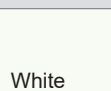

White

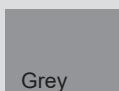

Grey

Base Price: € 4.670,00

### CONTROLS



INCLUDED

cod. LEM-070  
Foot pedal control € --,--

or



cod. LEM-180  
Wireless foot pedal control (NO foot pedal with cable NO remote control) € 219,00



cod. KEE00527  
Handset Control € 91,00

### MATTRESS



INCLUDED

cod. 305-M  
Standard mattress € --,--

### LEG SUPPORTS



INCLUDED

cod. 989  
Thigh support couple with handles couple € --,--



cod. 348  
Foot support couple

ALTERNATIVE TO € --,--  
thigh support couple

IN ADDITION TO € 448,00  
thigh support couple

### ELECTRIC SYSTEM



INCLUDED

cod. KEE00471  
EU Cable 230V € --,--



cod. KEE00472  
UK Cable 230V € --,--



cod. KEE00474  
USA Cable 110V € --,--



cod. KEE00473  
Australian Cable 240V € --,--

### ACCESSORIES UPON REQUEST



cod. 311  
I.V. Rod € 94,00  
(fixed with rotating clamp and guides on the back)



cod. 345  
Fixed clamp € 91,00



cod. 346  
Rotating clamp € 91,00



cod. 313  
Medical armrest couple € 281,00  
(to be fixed with rotating clamp and guides on the back)



cod. 1162  
Blood sample taking armrest couple € 458,00  
(fixed with flx clamp and guides on the seat)



cod. 315  
Curtain holder € 57,00  
(fixed with rotating clamp and guides on the seat)



cod. 306-M  
Leg Support € 219,00



cod. 208  
Flat automatic armrest couple € 260,00



cod. 335 / cod. 335 XL  
Back guides couple / Back guides couple XL € 198,00



cod. 360  
Colposcope support € 281,00



cod. LEM-139  
Wheels with brake (ø 50 mm) € 18,00 ea.



cod. 1059  
GYNO LAMP, flexible arm L 65 cm, equipped with metal plate with tube diameter 16 mm. To be fixed with rotating clamp (cod. 346) € 437,00



cod. 354 NEW  
Inox tray with support € 198,00  
(fixed with flx clamp and guides on the seat)



PROT. TESTA  
cod. PROT. TESTA € 22,00  
Plastic protection for head support



cod. LOGO  
Customized mattress with logo € 136,00

MANDATORY

UPON REQUEST

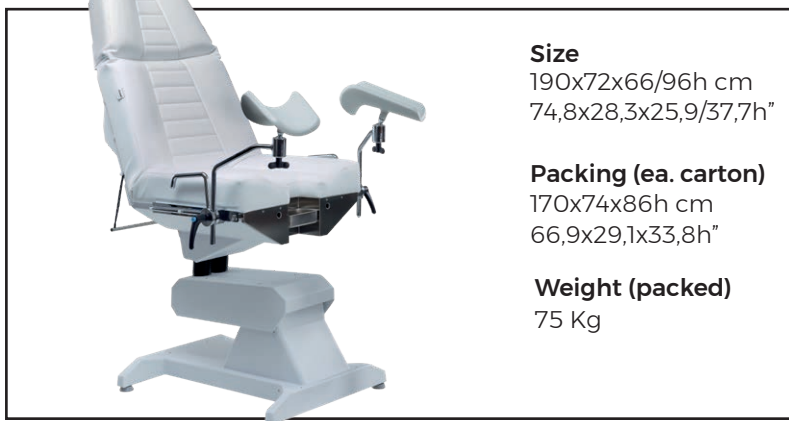

**Size**  
190x72x66/96h cm  
74,8x28,3x25,9/37,7h"

**Packing (ea. carton)**  
170x74x86h cm  
66,9x29,1x33,8h"

**Weight (packed)**  
75 Kg

cod. 302

# LEMI GYNO

Chair for gynaecology with electric adjustment

**Included:**

- 3 motors (height, back, trendelenburg)
- Seat guides couple
- Thigh supports couple
- Fixed clamps couple
- Hand grips couple
- Inox basin for organic waste
- Roll holder
- Foot pedal control with automatic function (height and trendelenburg)

**FRAME COLORS**

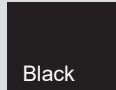
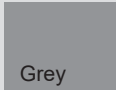
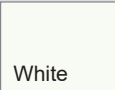

Base Price: € 4.200,00

**CONTROLS**



**INCLUDED**

cod. LEM-070  
Foot pedal control € --,--

or



cod. LEM-180  
Wireless foot pedal control (NO foot pedal with cable NO remote control) € 219,00



cod. KEE00494  
Handset Control € 91,00

**MATTRESS**



**INCLUDED**

cod. 326  
Standard mattress € --,--

**SEAT**



**INCLUDED**

cod. 959  
Fixed seat € --,--



cod. ROT  
Seat with 180° rotation € 156,00

**ELECTRIC SYSTEM**



**INCLUDED**

cod. KEE00471  
EU Cable 230V € --,--



cod. KEE00472  
UK Cable 230V € --,--



cod. KEE00474  
USA Cable 110V € --,--



cod. KEE00473  
Australian Cable 240V € --,--

**ACCESSORIES UPON REQUEST**



cod. 311  
I.V. Rod € 94,00  
(fixed with rotating clamp and guides on the back)



cod. 345  
Fixed clamp € 91,00



cod. 346  
Rotating clamp € 91,00



cod. 313  
Medical armrest couple € 281,00  
(to be fixed with rotating clamp and guides on the back)



cod. 315  
Curtain holder € 57,00  
(fixed with rotating clamp and guides on the seat)



cod. 310  
Leg Support € 219,00



cod. 335 / cod. 335 XL  
Back guides couple / Back guides couple XL € 198,00



cod. 360  
Colposcope support € 281,00



cod. LEM-151  
Heel support couple € 448,00  
(fixed with fix clamp and guides on the seat)



cod. LEM-139  
Wheels with brake (ø 50 mm) € 18,00 ea.



cod. 1059  
GYNO LAMP, flexible arm L 65 cm, equipped with metal plate with tube diameter 16 mm. To be fixed with rotating clamp (cod. 346) € 437,00



cod. 354 NEW  
Inox tray with support € 198,00  
(fixed with fix clamp and guides on the seat)



cod. LOGO  
Customized mattress with logo € 136,00

MANDATORY

UPON REQUEST



**Size**  
190x62x67/83h cm  
74,8x24,4x26,3/32,6h"

**Packing (ea. carton)**  
170x74x86h cm  
66,9x29,1x33,8h"

**Weight (packed)**  
68 Kg

## cod. 301 LEMI HYDROGYNO

Chair for gynaecology with hydraulic lift

### Included:

- Height adjustment by oleodynamic pump
- Rotation 360°
- Seat guides couple
- Thigh support couple
- Fixed clamps couple
- Hand grips couple
- Inox basin for organic waste
- Roll holder

### FRAME COLORS

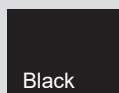
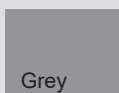
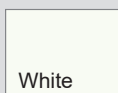

Base Price: € 2.900,00

### SEAT



#### INCLUDED

**cod. ROT**  
Seat with 360° rotation € --,--

### MATTRESS



#### INCLUDED

**cod. 326**  
Standard mattress € --,--

### ACCESSORIES UPON REQUEST



**cod. 311**  
I.V. Rod € 94,00  
(fixed with rotating clamp and guides on the back)



**cod. 360**  
Colposcope support € 281,00



**cod. 345**  
Fixed clamp € 91,00



**cod. LEM-151**  
Heel support couple € 448,00  
(fixed with fix clamp and guides on the seat)



**cod. 346**  
Rotating clamp € 91,00



**cod. LEM-139**  
Wheels with brake (ø 50 mm) € 18,00 ea.



**cod. 313**  
Medical armrest couple € 281,00  
(to be fixed with rotating clamp and guides on the back)



**cod. 1059**  
GYNO LAMP, flexible arm L 65 cm, equipped with metal plate with tube diameter 16 mm. To be fixed with rotating clamp (cod. 346) € 437,00



**cod. 315**  
Curtain holder € 57,00  
(fixed with rotating clamp and guides on the seat)



**cod. 354 NEW**  
Inox tray with support € 198,00  
(fixed with fix clamp and guides on the seat)



**cod. 310**  
Leg Support € 219,00



**cod. LOGO**  
Customized mattress with logo € 136,00



**cod. 335 / cod. 335 XL**  
Back guides couple / Back guides couple XL € 198,00

MANDATORY

UPON REQUEST

NEW



**Size**  
203x66x49/98h cm  
79,9x25,9x19,2/38,5h"

**Packing (ea. carton)**  
205x82x87h cm  
80,7x32,2x34,2h"

**Weight (packed)**  
88 Kg

cod. 1093

# LEMI PHYSIOBED

Two sections table with electric height adjustment

**Included:**

- 1 motor (height)
- Two sections mattress with face hole
- Manual back movement with gaslift
- Perimetral bar control
- Roll holder

**FRAME COLORS**

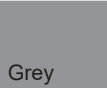

Base Price: € 2.300,00

**CONTROLS**



INCLUDED

cod. KMC00062 € --,--  
Perimetral bar control

or



cod. KEE00449 € --,--  
Foot pedal control

**MATTRESS**



INCLUDED

cod. 1128-667 € --,--  
Standard Mattress

**ELECTRIC SYSTEM**



INCLUDED

cod. 002481 € --,--  
EU Cable 230V



cod. KEE00397 € --,--  
UK Cable 230V



cod. KEE00434 € --,--  
USA Cable 110V

**ACCESSORIES**



cod. KMC00063 € 250,00  
Transfer wheels system



cod. 345 € 91,00  
Fixed clamp



cod. KMC00060 € 198,00  
Short guides couple



cod. 313 € 281,00  
Medical armrest couple  
(to be fixed with rotating clamp and guides on the back)

MANDATORY

UPON REQUEST

cod. 1126 [ EX: cod. 066 ]

# SOSUL

Three sections table with electric height adjustment

### Included:

- 1 motor (height)
- Three sections mattress
- Manual back and leg movement
- Zak head rest (adjustable and extractable)
- Foot pedal control

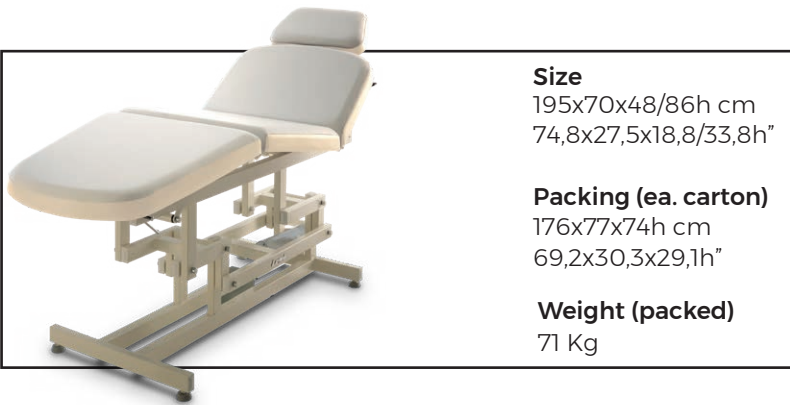

**Size**  
195x70x48/86h cm  
74,8x27,5x18,8/33,8h"

**Packing (ea. carton)**  
176x77x74h cm  
69,2x30,3x29,1h"

**Weight (packed)**  
71 Kg

### FRAME COLORS

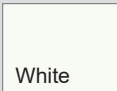

White

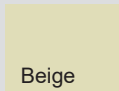

Beige

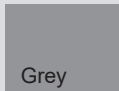

Grey

Base Price: € 1.660,00

### CONTROLS



INCLUDED

cod. KEE00449  
Foot pedal control € --,--

### MATTRESS



INCLUDED

cod. 125  
Standard 3 section mattress € --,--

### ELECTRIC SYSTEM



INCLUDED

cod. 002481  
EU Cable 230V € --,--



cod. KEE00397  
UK Cable 230V € --,--



cod. KEE00434  
USA Cable 110V € --,--

### ACCESSORIES UPON REQUEST



cod. 069  
Armrest Couple € 188,00



cod. LEM-139  
Wheels with brake (ø 50 mm) € 18,00 ea.



cod. 114 P  
Mattress protection with polyurethane € 90,00



cod. PROT.GAMBE  
Plastic leg protection € 48,00



cod. 183  
Strip headrest with face hole € 271,00



cod. LOGO  
Customized mattress with logo € 136,00



cod. 108  
Roll holder € 41,00

MANDATORY

UPON REQUEST



**Size**  
190x72x77h cm  
74,8x28,3x30,3h"

**Packing (ea. carton)**  
203x82x40h cm  
79,9x32,2x15,7h"

**Weight (packed)**  
49 Kg

cod. 002  
**WELL (with face hole)**  
Stationary examination table

**Included:**

- Manual back rest adjustment
- Roll holder
- Mattress with face hole

**FRAME COLORS**

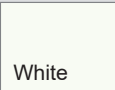

White

Base Price: € 820,00

MANDATORY

**ACCESSORIES UPON REQUEST**



**cod. 114 P**  
Mattress protection with polyurethane

€ 90,00



**cod. LOGO**  
Customized mattress with logo

€ 136,00



**cod. A-WEL-Re**  
Shelf for accessories

€ 136,00

UPON REQUEST

cod. 1142 [ EX: cod. 367 ]

# SOMED

Two sections examination table

### Included:

- 1 motor (height)
- Manual back rest adjustment



**Size**  
190x68x48/86h cm  
74,8x26,7x18,8/33,8h"

**Packing (ea. carton)**  
205x82x87h cm  
80,7x32,2x34,2h"

**Weight (packed)**  
77 Kg

### FRAME COLORS

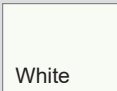

White

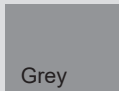

Grey

Base Price: € 1.660,00

### CONTROLS



INCLUDED

cod. KEE00449

Foot pedal control

€ --,--

### MATTRESS

INCLUDED



cod. 367-M

Mattress without face hole

€ --,--



cod. 367-M-F

Mattress with face hole

€ 33,00

### ELECTRIC SYSTEM



INCLUDED

cod. 002481

EU Cable 230V

€ --,--



cod. KEE00397

UK Cable 230V

€ --,--



cod. KEE00434

USA Cable 110V

€ --,--

### ACCESSORIES UPON REQUEST



cod. 114 P

Mattress protection with polyurethane

€ 90,00



cod. LEM-139

Wheels with brake (ø 50 mm)

€ 18,00 ea.



cod. 108

Roll holder

€ 41,00



cod. LOGO

Customized mattress with logo

€ 136,00

MANDATORY

UPON REQUEST

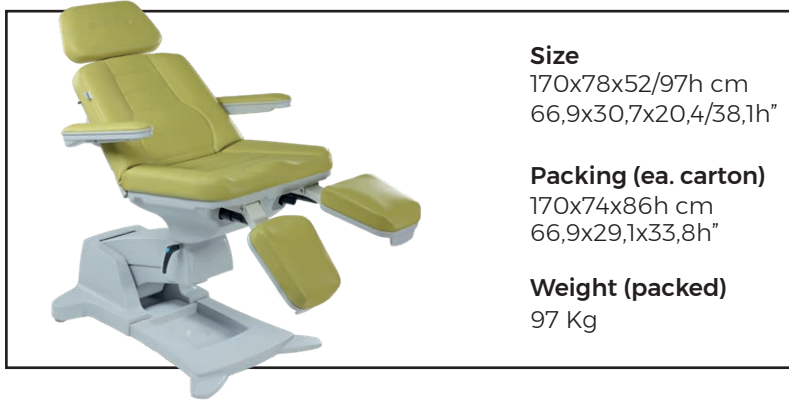

**Size**  
170x78x52/97h cm  
66,9x30,7x20,4/38,1h"

**Packing (ea. carton)**  
170x74x86h cm  
66,9x29,1x33,8h"

**Weight (packed)**  
97 Kg

**cod. 218**  
**PODO 5**  
Fully electric podiatry chair

**Included:**

- 5 motors (height, back, Trendelenburg, single leg adjustments)
- Adjustable and extractable head rest
- Electrically adjustable and removable legrest
- Flat armrests couple
- 180° rotation
- Foot pedal control with automatic function

**FRAME COLORS**

Grey

Base Price: € 4.270,00

**CONTROLS**



**INCLUDED**

**cod. LEM-183**  
Foot pedal control € --,--

**LEG OPTIONS**



**INCLUDED**

**cod. 976**  
Standard Legrest € --,--



**cod. 977**  
Option for splitted legrest € 240,00

**ELECTRIC SYSTEM**



**INCLUDED**

**cod. KEE00471**  
EU Cable 230V € --,--



**cod. KEE00472**  
UK Cable 230V € --,--



**cod. KEE00474**  
USA Cable 110V € --,--



**cod. KEE00473**  
Australian Cable 240V € --,--

**ACCESSORIES UPON REQUEST**



**cod. 212**  
Cushion between seat and leg rest € 156,00



**cod. LEM-152**  
Leg rest covering (1 pack= 100 pcs) € 167,00



**cod. 108**  
Roll holder € 41,00



**cod. NO CUCITURE**  
Option for mattress without stitching € --,--



**cod. LEM-139**  
Wheels with brake (ø 50 mm) € 18,00 ea.



**cod. PROT.GAMBE PODO**  
Plastic leg protection (couple) € 26,00 (couple)



**cod. LOGO**  
Customized mattress with logo € 136,00

MANDATORY

UPON REQUEST



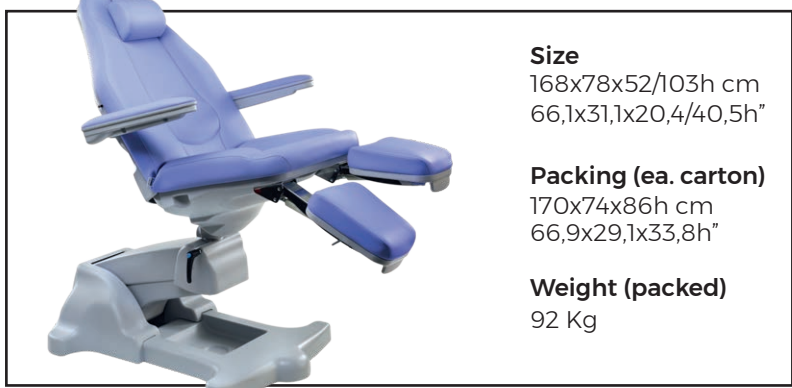

**Size**  
168x78x52/103h cm  
66,1x31,1x20,4/40,5h"

**Packing (ea. carton)**  
170x74x86h cm  
66,9x29,1x33,8h"

**Weight (packed)**  
92 Kg

cod. 204

# PODO HIGH

Podiatry chair electrically adjustable

**Included:**

- 3 motors (height, back and Trendelenburg adjustments)
- Automatic, adjustable and extractable legs with 90° side opening
- Flat armrests couple
- 180° rotation
- Head support
- Foot pedal control with automatic function

**FRAME COLORS**

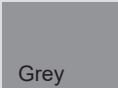

Grey

Base Price: € 4.020,00

**CONTROLS**



INCLUDED

cod. LEM-070  
Foot pedal control € --,--

or



cod. LEM-179  
Wireless foot pedal control (NO foot pedal with cable NO remote control) € 219,00



cod. KEE00494  
Handset Control € 91,00

**LEG OPTIONS**



INCLUDED

cod. 929  
Standard Automatic Legrest € --,--



cod. 930  
Option for splitted automatic legrest € 240,00

**ELECTRIC SYSTEM**



INCLUDED

cod. KEE00471  
EU Cable 230V € --,--



cod. KEE00472  
UK Cable 230V € --,--



cod. KEE00474  
USA Cable 110V € --,--



cod. KEE00473  
Australian Cable 240V € --,--

**ACCESSORIES UPON REQUEST**



cod. 212  
Cushion between seat and leg rest € 156,00



cod. LEM-152  
Leg rest covering (1 pack= 100 pcs) € 167,00



cod. 108  
Roll holder € 41,00



cod. LEM-139  
Wheels with brake (ø 50 mm) € 18,00 ea.



PROT. TESTA  
cod. PROT. TESTA  
Plastic protection for head support € 22,00



cod. PROT.GAMBE PODO  
Plastic leg protection (couple) € 26,00 (couple)



cod. LOGO  
Customized mattress with logo € 136,00

MANDATORY

UPON REQUEST

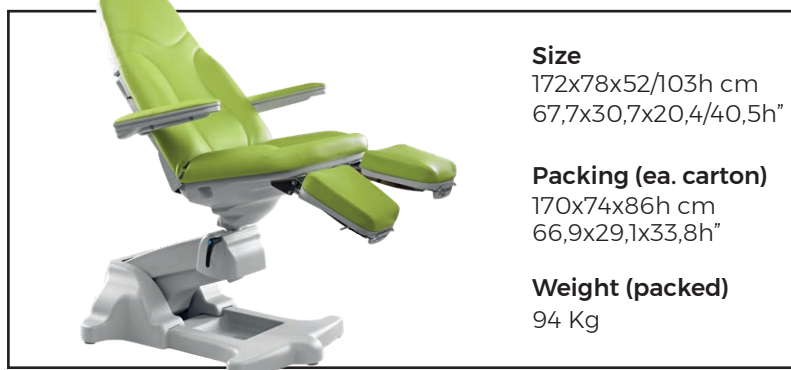

**Size**  
172x78x52/103h cm  
67,7x30,7x20,4/40,5h"

**Packing (ea. carton)**  
170x74x86h cm  
66,9x29,1x33,8h"

**Weight (packed)**  
94 Kg

cod. 213

# PODO BRUSO

Podiatry chair electrically adjustable

**Included:**

- 3 motors (height, back and Trendelenburg)
- Adjustable and extractable legs with 90° side opening
- Flat armrests couple
- 180° rotation
- Foot pedal control with automatic function

**AVAILABLE WHILE STOCKS LAST**

**FRAME COLORS**



Base Price: € 4.130,00

**CONTROLS**



**INCLUDED**

cod. LEM-070  
Foot pedal control € --,--

OR

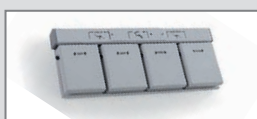

cod. LEM-179  
Wireless foot pedal control (NO foot pedal with cable NO remote control) € 219,00



cod. KEE00494  
Handset Control € 91,00

**LEG OPTIONS**



**INCLUDED**

cod. 929  
Standard Automatic Legrest € --,--



cod. 930  
Option for splitted automatic legrest € 240,00

**ELECTRIC SYSTEM**



**INCLUDED**

cod. KEE00471  
EU Cable 230V € --,--



cod. KEE00472  
UK Cable 230V € --,--



cod. KEE00474  
USA Cable 110V € --,--



cod. KEE00473  
Australian Cable 240V € --,--

**ACCESSORIES UPON REQUEST**



cod. 212  
Cushion between seat and leg rest € 156,00



cod. LEM-139  
Wheels with brake (ø 50 mm) € 18,00 ea.



cod. LEM-152  
Leg rest covering (1 pack= 100 pcs) € 167,00



cod. PROT.GAMBE PODO  
Plastic leg protection (couple) € 26,00 (couple)



cod. 108  
Roll holder € 41,00



cod. LOGO  
Customized mattress with logo € 136,00

MANDATORY

UPON REQUEST



**Size**  
168x78x52/82h cm  
66,1x30,7x20,4/32,2h"

**Packing (ea. carton)**  
170x74x86h cm  
66,9x29,1x33,8h"

**Weight (packed)**  
85 Kg

cod. 205

# PODO DREAM

Podiatry chair electrically adjustable

## Included:

- 3 motors (height, back and Trendelenburg)
- Adjustable and extractable legs with 90° side opening
- Flat armrests couple
- 180° rotation
- Head support
- Foot pedal control with automatic function

## FRAME COLORS

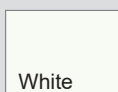

White

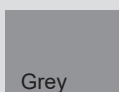

Grey

Base Price: € 3.680,00

## CONTROLS



INCLUDED

cod. LEM-070  
Foot pedal control € --,--

OR

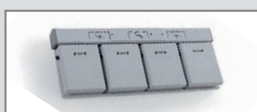

cod. LEM-179  
Wireless foot pedal control (NO foot pedal with cable NO remote control) € 219,00



cod. KEE00494  
Handset Control € 91,00

## LEG OPTIONS



INCLUDED

cod. 929  
Standard Automatic Legrest € --,--



cod. 930  
Option for splitted automatic legrest € 240,00

## ELECTRIC SYSTEM



INCLUDED

cod. KEE00462  
EU Cable 230V € --,--



cod. KEE00463  
UK Cable 230V € --,--



cod. KEE00465  
USA Cable 110V € --,--



cod. KEE00464  
Australian Cable 240V € --,--

## ACCESSORIES UPON REQUEST



cod. 212  
Cushion between seat and leg rest € 156,00



cod. LEM-152  
Leg rest covering (1 pack= 100 pcs) € 167,00



cod. 108  
Roll holder € 41,00



cod. LEM-139  
Wheels with brake (ø 50 mm) € 18,00 ea.



cod. PROT. TESTA  
Plastic protection for head support € 22,00



cod. PROT.GAMBE PODO  
Plastic leg protection (couple) € 26,00 (couple)



cod. LOGO  
Customized mattress with logo € 136,00

MANDATORY

UPON REQUEST

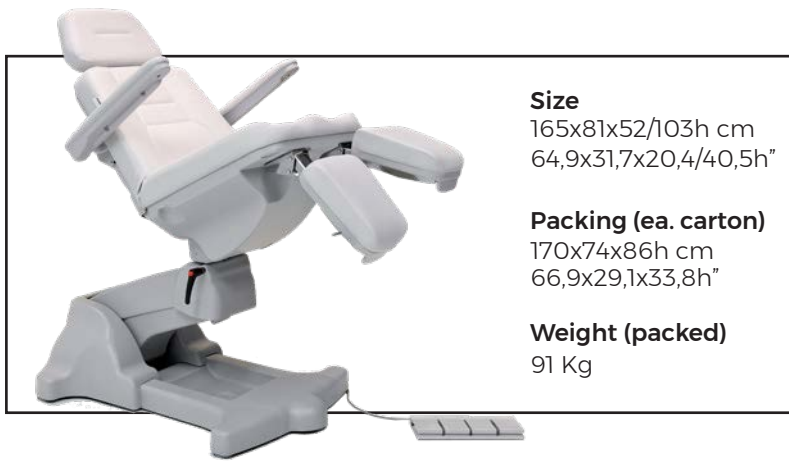

**Size**  
165x81x52/103h cm  
64,9x31,7x20,4/40,5h"

**Packing (ea. carton)**  
170x74x86h cm  
66,9x29,1x33,8h"

**Weight (packed)**  
91 Kg

cod. 204-2

# PODO MIX 3M

Podiatry chair electrically adjustable

**Included:**

- 3 motors (height and back adjustment, Trendelenburg)
- Zak head rest
- Flat armrests couple
- 180° rotation
- Adjustable and removable legs with 90° side opening
- Foot pedal control with automatic function

**FRAME COLORS**



White

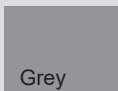

Grey

Base Price: € 3.990,00

**CONTROLS**



**INCLUDED**

cod. LEM-070  
Foot pedal control € --,--

OR



cod. LEM-179  
Wireless foot pedal control (NO foot pedal with cable NO remote control) € 219,00

**LEG OPTIONS**



**INCLUDED**

cod. 929  
Standard Automatic Legrest € --,--



cod. 930  
Option for splitted automatic legrest € 240,00

**ELECTRIC SYSTEM**



**INCLUDED**

cod. KEE00471  
EU Cable 230V € --,--



cod. KEE00472  
UK Cable 230V € --,--



cod. KEE00474  
USA Cable 110V € --,--



cod. KEE00473  
Australian Cable 240V € --,--

**ACCESSORIES UPON REQUEST**



cod. 212  
Cushion between seat and leg rest € 156,00



cod. LEM-152  
Leg rest covering (1 pack= 100 pcs) € 167,00



cod. 108  
Roll holder € 41,00



cod. LEM-139  
Wheels with brake (ø 50 mm) € 18,00 ea.



cod. 217-W  
Wellness mattress € 302,00



cod. PROT.GAMBE PODO  
Plastic leg protection (couple) € 26,00 (couple)



cod. NO CUCITURE  
Option for mattress without stitching € --,--



cod. LOGO  
Customized mattress with logo € 136,00

MANDATORY

UPON REQUEST

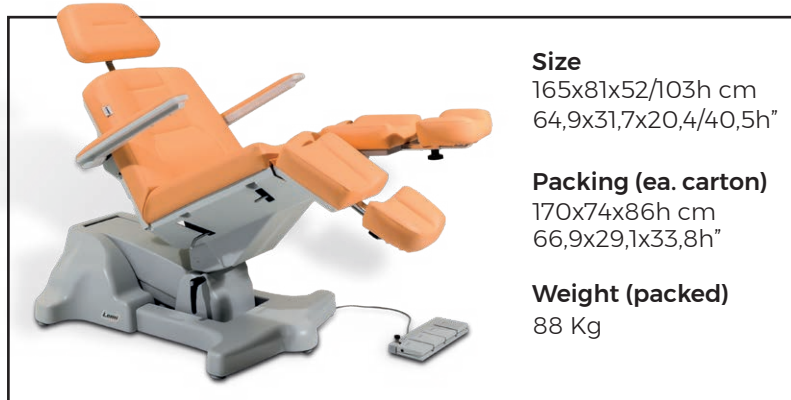

**Size**  
165x81x52/103h cm  
64,9x31,7x20,4/40,5h"

**Packing (ea. carton)**  
170x74x86h cm  
66,9x29,1x33,8h"

**Weight (packed)**  
88 Kg

cod. 204-1

# PODO MIX 2M

Podiatry chair with electric lift adjustment

**Included:**

- 2 motors (height and Trendelenburg)
- Zak head rest
- Manual back adjustment
- Manual adjustment of the legs with removable foot
- Flat armrests couple
- 180° rotation
- Foot pedal control with automatic function

**FRAME COLORS**

Grey

Base Price: € 3.470,00

MANDATORY

**CONTROLS**



**INCLUDED**

cod. LEM-068  
Foot pedal control € --,--

**ELECTRIC SYSTEM**



**INCLUDED**

cod. KEE00471  
EU Cable 230V € --,--



cod. KEE00472  
UK Cable 230V € --,--



cod. KEE00474  
USA Cable 110V € --,--



cod. KEE00473  
Australian Cable 240V € --,--

**ACCESSORIES UPON REQUEST**



cod. 108  
Roll holder € 41,00



cod. LOGO  
Customized mattress with logo € 136,00



cod. LEM-139  
Wheels with brake (ø 50 mm) € 18,00 ea.

UPON REQUEST

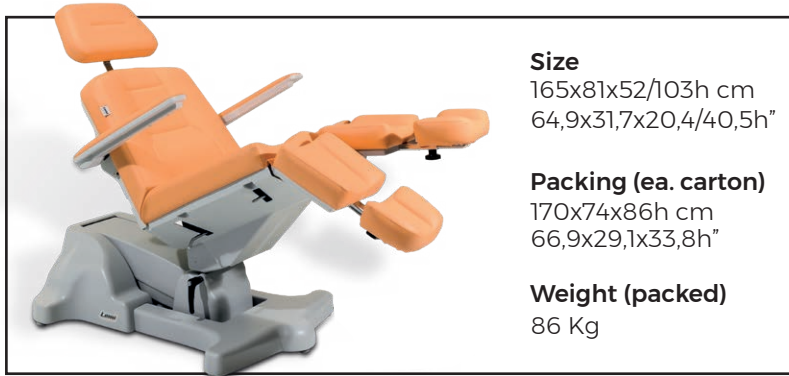

**Size**  
165x81x52/103h cm  
64,9x31,7x20,4/40,5h"

**Packing (ea. carton)**  
170x74x86h cm  
66,9x29,1x33,8h"

**Weight (packed)**  
86 Kg

cod. 204-3

# PODO MIX 1M

Podiatry chair with electric lift adjustment

**Included:**

- 1 motor (height adjustment)
- Manual backrest and legrests adjustment
- Zak head rest
- Flat armrests couple
- 180° rotation
- Manual trendelenburg
- Foot pedal control

**FRAME COLORS**

Grey

Base Price: € 2.840,00

MANDATORY

**CONTROLS**



INCLUDED

cod. LEM-069  
Foot pedal control € --,--

**ELECTRIC SYSTEM**

INCLUDED



cod. KEE00471  
EU Cable 230V € --,--



cod. KEE00472  
UK Cable 230V € --,--



cod. KEE00474  
USA Cable 110V € --,--



cod. KEE00473  
Australian Cable 240V € --,--

**ACCESSORIES UPON REQUEST**



cod. 108  
Roll holder € 41,00



cod. LOGO  
Customized mattress with logo € 136,00



cod. LEM-139  
Wheels with brake (ø 50 mm) € 18,00 ea.

UPON REQUEST

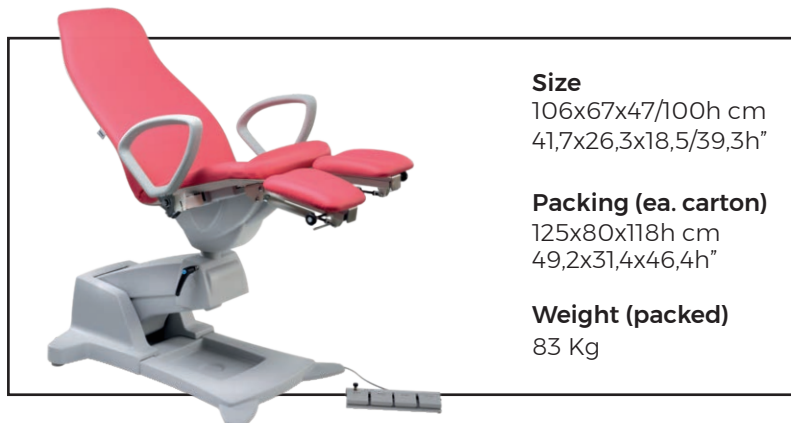

**Size**  
106x67x47/100h cm  
41,7x26,3x18,5/39,3h"

**Packing (ea. carton)**  
125x80x118h cm  
49,2x31,4x46,4h"

**Weight (packed)**  
83 Kg

cod. 214

# PODO SLINDER

Podiatry chair electrically adjustable

## Included:

- 2 motors (height adjustment, Trendelenburg)
- Manual back rest adjustment
- Manual leg movement with side opening
- Bat armrests
- 180° rotation with 90° side opening
- Foot pedal control with automatic function

## FRAME COLORS

Grey

Base Price: € 3.080,00

MANDATORY

## CONTROLS



INCLUDED

cod. LEM-068  
Foot pedal control € --,--

## ELECTRIC SYSTEM



INCLUDED

cod. KEE00471  
EU Cable 230V € --,--



cod. KEE00472  
UK Cable 230V € --,--



cod. KEE00474  
USA Cable 110V € --,--



cod. KEE00473  
Australian Cable 240V € --,--

## ACCESSORIES UPON REQUEST



cod. LEM-152  
Leg rest covering (1 pack= 100 pcs) € 167,00



cod. 205-T  
Head support € 54,00



cod. KMC00044  
Roll holder € 41,00



PROT.  
TESTA  
cod. PROT. TESTA  
Plastic protection for head support € 22,00



cod. LEM-139  
Wheels with brake (ø 50 mm) € 18,00 ea.



cod. LOGO  
Customized mattress with logo € 136,00

UPON REQUEST



**Size**

Lamp head:  
11x10 cm  
4,3x3,9"

Lamp base:  
6,9x6,9x11,5 cm  
2,7x2,7x4,5"

**cod. 854**

# LED LAMP DERMATOLOGY 7W

**Included:**

- Flexible arm L. 114 cm

**FRAME COLORS**



White

Base price: € 499,00



**cod. 346**

To be fix with Rotating clamp

€ 91,00

MANDATORY



**Size**

Lamp head:  
6x10 cm  
2,3x3,9"

Lamp base:  
6,9x6,9x6 cm  
2,7x2,7x2,3"

**cod. 1059**

# LED LAMP GYNO 10°

**Included:**

- Flexible arm L. 100 cm

**FRAME COLORS**

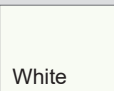

White

Base price: € 437,00



**cod. 346**

To be fix with Rotating clamp

€ 91,00

MANDATORY



# MATTRESS CUSTOMIZATION

## FABRICS FINISHES

The images are for illustrative purposes only and may not reflect the actual finish of the product, particularly when viewed through a screen.

Therefore, the **SELECTION** of the mattress **FABRICS** must take place **AFTER CONSULTING** the **PHYSICAL SAMPLES** of the NEFOS **COLOR CHART**.

### INCLUDED

#### NEFOS COLORS



Price: € --,-- ea.

---

# STOOLS



**Packing (ea. carton)**  
61x23x61h cm  
24x9x24h"

**Weight (packed)**  
6 Kg

# 030

Stool with gaslift regulation  
(h. min. cm 46 - h max. cm 57)

**Included:**

- Gray plastic base
- Round seat

Base Price: € 200,00

**BASE TYPE**



**INCLUDED**

**cod. SGB 001**  
Plastic grey base

€ --,--



**cod. SGB 030**  
Aluminium base  
Ø50 cm/ 19,6"

€ 52,00

MANDATORY



**Packing (ea. carton)**  
61x23x61h cm  
24x9x24h"

**Weight (packed)**  
9 Kg

# 030/S

Stool with gaslift regulation  
(h. min. cm 46 - h max. cm 57)

**Included:**

- Gray plastic base
- Adjustable backrest
- Round seat

Base Price: € 240,00

**BASE TYPE**



**INCLUDED**

**cod. SGB 001**  
Plastic grey base

€ --,--



**cod. SGB 030**  
Aluminium base  
Ø50 cm/ 19,6"

€ 52,00

MANDATORY



**Packing (ea. carton)**  
61x23x61h cm  
24x9x24h"

**Weight (packed)**  
6 Kg

# 030 PEDI

Low stool for pedicure with gaslift regulation  
(h. min. cm 42 - h max. cm 52)

**Included:**

- Gray plastic base
- Round seat

Base Price: € 200,00

**BASE TYPE**



**INCLUDED**  
cod. SGB 001  
Plastic grey base

€ --,--



cod. SGB 030  
Aluminium base  
Ø50 cm/ 19,6"

€ 52,00

MANDATORY



**Packing (ea. carton)**  
61x23x61h cm  
24x9x24h"

**Weight (packed)**  
9 Kg

# 030/S PEDI

Low stool for pedicure with gaslift regulation  
(h. min. cm 42 - h max. cm 52)

**Included:**

- Gray plastic base
- Adjustable backrest
- Round seat

Base Price: € 240,00

**BASE TYPE**



**INCLUDED**  
cod. SGB 001  
Plastic grey base

€ --,--



cod. SGB 030  
Aluminium base  
Ø50 cm/ 19,6"

€ 52,00

MANDATORY



**Packing (ea. carton)**  
61x23x61h cm  
24x9x24h"

**Weight (packed)**  
6 Kg

# 050

Stool with gaslift regulation  
(h. min. cm 46 - h max. cm 57)

**Included:**

- Gray plastic base
- Saddle seat

Base Price: € 200,00

**BASE TYPE**



**INCLUDED**

**cod. SGB 001**  
Plastic grey base

€ --,--



**cod. SGB 030**  
Aluminium base  
Ø50 cm/ 19,6"

€ 52,00

MANDATORY



**Packing (ea. carton)**  
61x23x61h cm  
24x9x24h"

**Weight (packed)**  
9 Kg

# 050/S

Stool with gaslift regulation  
(h. min. cm 46 - h max. cm 57)

**Included:**

- Gray plastic base
- Adjustable backrest
- Saddle seat

Base Price: € 240,00

**BASE TYPE**



**INCLUDED**

**cod. SGB 001**  
Plastic grey base

€ --,--



**cod. SGB 030**  
Aluminium base  
Ø50 cm/ 19,6"

€ 52,00

MANDATORY



**Packing (ea. carton)**  
61x23x61h cm  
24x9x24h"

**Weight (packed)**  
6 Kg

# 050 PEDI

Low stool for pedicure with gaslift regulation  
(h. min. cm 42 - h max. cm 52)

**Included:**

- Gray plastic base
- Saddle seat

Base Price: € 200,00

**BASE TYPE**



**INCLUDED**

**cod. SGB 001**  
Plastic grey base

€ --,--



**cod. SGB 030**  
Aluminium base  
Ø50 cm/ 19,6"

€ 52,00

MANDATORY



**Packing (ea. carton)**  
61x23x61h cm  
24x9x24h"

**Weight (packed)**  
9 Kg

# 050/S PEDI

Low stool for pedicure with gaslift regulation  
(h. min. cm 42 - h max. cm 52)

**Included:**

- Gray plastic base
- Adjustable backrest
- Saddle seat

Base Price: € 240,00

**BASE TYPE**



**INCLUDED**

**cod. SGB 001**  
Plastic grey base

€ --,--



**cod. SGB 030**  
Aluminium base  
Ø50 cm/ 19,6"

€ 52,00

MANDATORY



**Packing (ea. carton)**  
61x23x61h cm  
24x9x24h"

**Weight (packed)**  
8 Kg

## 021

High stool for make-up with gaslift regulation  
(h. min. cm 56 - h max. cm 73)

**Included:**

- Gray plastic base
- Footrest ring
- Round seat

Base Price: € 230,00

### BASE TYPE



**INCLUDED**

**cod. SGB 001**  
Plastic grey base

€ --,--



**cod. SGB 030**  
Aluminium base  
Ø50 cm/ 19,6"

€ 52,00

MANDATORY



**Packing (ea. carton)**  
61x23x61h cm  
24x9x24h"

**Weight (packed)**  
12 Kg

## 021/S

High stool for make-up with gaslift regulation  
(h. min. cm 56 - h max. cm 73)

**Included:**

- Gray plastic base
- Footrest ring
- Adjustable backrest
- Round seat

Base Price: € 290,00

### BASE TYPE



**INCLUDED**

**cod. SGB 001**  
Plastic grey base

€ --,--



**cod. SGB 030**  
Aluminium base  
Ø50 cm/ 19,6"

€ 52,00

MANDATORY



**Packing (ea. carton)**  
61x23x61h cm  
24x9x24h"

**Weight (packed)**  
7 Kg

# 035

High stool for make-up with gaslift regulation  
(h. min. cm 56 - h max. cm 73)

**Included:**

- Gray plastic base
- Footrest ring
- Saddle seat

Base Price: € 230,00

**BASE TYPE**



**INCLUDED**

**cod. SGB 001**  
Plastic grey base

€ --,--



**cod. SGB 030**  
Aluminium base  
Ø50 cm/ 19,6"

€ 52,00

MANDATORY



**Packing (ea. carton)**  
61x23x61h cm  
24x9x24h"

**Weight (packed)**  
10 Kg

# 035/S

High stool for make-up with gaslift regulation  
(h. min. cm 56 - h max. cm 73)

**Included:**

- Gray plastic base
- Footrest ring
- Adjustable backrest
- Saddle seat

Base Price: € 290,00

**BASE TYPE**



**INCLUDED**

**cod. SGB 001**  
Plastic grey base

€ --,--



**cod. SGB 030**  
Aluminium base  
Ø50 cm/ 19,6"

€ 52,00

MANDATORY





**Packing (ea. carton)**

61x23x61h cm  
24x9x24h"

**Weight (packed)**

6 Kg

# 052

Horse saddle stool  
(h. min. cm 56 - h max. cm 73)

**Included:**

- Aluminum base Ø 60 cm
- Horse saddle seat

Base Price: € 280,00

**BASE TYPE**



**INCLUDED**

**cod. SGB 006**  
Aluminium base  
Ø50 cm/ 19,6"

€ --,--



**cod. SGB 001**  
Plastic grey base

€ 52,00

MANDATORY



**Packing (ea. carton)**

61x23x61h cm  
24x9x24h"

**Weight (packed)**

9 Kg

# 052/S

Horse saddle stool  
(h. min. cm 56 - h max. cm 73)

**Included:**

- Aluminum base Ø 60 cm
- Adjustable backrest
- Horse saddle seat

Base Price: € 340,00

**BASE TYPE**



**INCLUDED**

**cod. SGB 006**  
Aluminium base  
Ø50 cm/ 19,6"

€ --,--



**cod. SGB 001**  
Plastic grey base

€ 52,00

MANDATORY



**Packing (ea. carton)**  
61x23x61h cm  
24x9x24h"

**Weight (packed)**  
6 Kg

# 015

Seamless round stool  
(h. min. cm 46 - h max. cm 57)

**Included:**

- Gray plastic base
- Round seamless seat

Base Price: € 170,00

**BASE TYPE**



**INCLUDED**

**cod. SGB 001**  
Plastic grey base

€ --,--



**cod. SGB 030**  
Aluminium base  
Ø50 cm/ 19,6"

€ 52,00

MANDATORY



**Packing (ea. carton)**  
61x23x61h cm  
24x9x24h"

**Weight (packed)**  
7 Kg

# 015 PEDI

Seamless round stool  
(h. min. cm 42 - h max. cm 52)

**Included:**

- Gray plastic base
- Round seamless seat

Base Price: € 170,00

**BASE TYPE**



**INCLUDED**

**cod. SGB 001**  
Plastic grey base

€ --,--



**cod. SGB 030**  
Aluminium base  
Ø50 cm/ 19,6"

€ 52,00

MANDATORY



**Packing (ea. carton)**  
61x23x61h cm  
24x9x24h"

**Weight (packed)**  
6 Kg

# 019

Saddle seamless stool  
(h. min. cm 46 - h max. cm 57)

**Included:**

- Gray plastic base
- Saddle seamless seat

Base Price: € 170,00

**BASE TYPE**



**INCLUDED**

**cod. SGB 001**  
Plastic grey base

€ --,--



**cod. SGB 030**  
Aluminium base  
Ø50 cm/ 19,6"

€ 52,00

MANDATORY



**Packing (ea. carton)**  
61x23x61h cm  
24x9x24h"

**Weight (packed)**  
7 Kg

# 019 PEDI

Saddle seamless stool for podology  
(h. min. cm 42 - h max. cm 52)

**Included:**

- Gray plastic base
- Saddle seamless seat

Base Price: € 170,00

**BASE TYPE**



**INCLUDED**

**cod. SGB 001**  
Plastic grey base

€ --,--



**cod. SGB 030**  
Aluminium base  
Ø50 cm/ 19,6"

€ 52,00

MANDATORY



**Packing (ea. carton)**

61x23x61h cm  
24x9x24h"

**Weight (packed)**

13 Kg

# 070 A

Small chair with gaslift regulation  
(h. min. cm 43 - h max. cm 57)

**Included:**

- Aluminum base Ø 60 cm
- Adjustable backrest

Base Price: € 300,00



**Packing (ea. carton)**

80x40x50h cm  
31,4x15,7x19,6h"

**Weight (packed)**

10 Kg

## 010

Stool with oleodinamic pump adjustment  
(h. min. cm 57 - h max. cm 73)

**Included:**

- Aluminium base
- Round seat

Base Price: € 400,00



**Packing (ea. carton)**

195x27x67h cm  
76,7x10,6x26,3h"

**Weight (packed)**

12 Kg

## 010/S

Stool with oleodinamic pump adjustment and  
adjustable backrest  
(h. min. cm 57 - h max. cm 73)

**Included:**

- Aluminium base
- Round seat
- Adjustable backrest

Base Price: € 460,00



**Packing (ea. carton)**

80x40x50h cm  
31,4x15,7x19,6h"

**Weight (packed)**

10 Kg

## 040

Stool with oleodinamic pump adjustment  
(h. min. cm 57 - h max. cm 73)

**Included:**

- Aluminium base
- Saddle seat

Base Price: € 400,00



**Packing (ea. carton)**

195x27x67h cm  
76,7x10,6x26,3h"

**Weight (packed)**

12 Kg

## 040/S

Stool with oleodinamic pump adjustment and  
adjustable backrest  
(h. min. cm 57 - h max. cm 73)

**Included:**

- Aluminium base
- Adjustable backrest
- Saddle seat

Base Price: € 460,00

# STOOLS CUSTOMIZATION

## FABRICS FINISHES

The images are for illustrative purposes only and may not reflect the actual finish of the product, particularly when viewed through a screen.

Therefore, the **SELECTION** of the mattress **FABRICS** must take place **AFTER CONSULTING** the **PHYSICAL SAMPLES** of the NEFOS **COLOR CHART**.

### INCLUDED

#### NEFOS COLORS



Price: € --,-- ea.

# SALES CONDITIONS

ALL PRICES INDICATED MUST BE CONSIDERED EXCLUDING VAT

**INCOTERMS:** Ex Works

**INSTALLATION:** at your charge according to installation schemes provided by manufacturer and in accordance with the regulations in force.

**WARRANTY PROCEDURE:** BRUSAFERRI & C. Srl ensures that delivered Products do not present any material or manufacturing defect and agrees to send spare parts for the defective products at his own charge, unless the Products have been damaged by third parties, wrongly installed or used or in any other case beyond BRUSAFERRI control, whereas the replacement of parts and the technical intervention is under responsibility and at charge of the distributor. The distributor is expected to send back defective spare parts at its own charge. Warranty decays if the Products have been damaged during transportation or wrongly installed. Brusaferrri commits to send operative instructions for the replacement of defective spare parts in order to ease the technical intervention of the distributor. Warranty terms refer to equipment MANUFACTURED by LEMI.

<b>1</b> anno/year/an/ año / Jahr	Riscaldamento materasso / Mattress heating / Chauffage matelas / Calefacción colchón / Heizung des Polsters
<b>2</b> anni/years/ans/ años /Jahre	Motori e controlli / Motors and controls / Moteurs et commandes / Motores y controles / Motoren und Steuerungen
<b>5</b> anni/years/ans/ años /Jahre	Gomma indeformabile / Undeformable foam / Mousse indéformable / Espuma indeformable / Nicht verformbarer Gummi des Polsters
<b>10</b> anni/years/ans/ años /Jahre	Struttura / Base / Piètement / Base / Struktur

**ACCEPTANCE OF GOODS:** the distributor must check the Products as soon as they arrive at his place's and promptly report to BRUSAFERRI & C. Srl any defect of manufacture. After 15 (fifteen) days since receipt of the Products without claim report, the Products will be regarded as definitely accepted.

**ACCESSORIES:** prices of accessories are valid only for those accessories purchased with the chairs and beds. For accessories needed as spare parts, please contact **service@lemigroup.it**

**EXPIRY DATE:** 31<sup>ST</sup> december 2021

**MONTH OF RELEASE:** May 2021





**Lemi**<sup>®</sup>  
ITALIAN WELLNESS EQUIPMENT

**Brusaferri & C. srl**  
Via Mara Maretti Soldi, 13  
26011 Casalbuttano (CR) Italy  
phone +039 0374 363069  
info@lemigroup.it

[www.lemigroup.com](http://www.lemigroup.com)